

# Auto-Ohm 200 S3 / DMOM-200 S3 / DMOM-600 True DC Digital Micro-Ohmmeters

## USER'S MANUAL



**Vanguard Instruments Company, Inc.**

1520 S. Hellman Ave.

Ontario, California 91761, USA

TEL: (909) 923-9390  
FAX: (909) 923-9391

July 2014  
Revision 2.2

## SAFETY SUMMARY

This manual applies to the Auto-Ohm 200 S3, the DMOM-200 S3, and the DMOM-600 digital micro-ohmmeters. The operating procedures are virtually the same for all three models, and any differences are clearly described where applicable.

### FOLLOW EXACT OPERATING PROCEDURES

Any deviation from the procedures described in this user's manual may create one or more safety hazards, damage the Auto-Ohm 200 S3/DMOM-200 S3/DMOM-600, or cause errors in the test results. Vanguard Instruments Co., Inc. assumes no liability for unsafe or improper use of the Auto-Ohm 200 S3/DMOM-200 S3/DMOM-600. The following safety precautions must be observed during all phases of test setup, test hookups, testing, and test lead disconnection.

### SAFETY WARNINGS AND CAUTIONS

The Auto-Ohm 200 S3/DMOM-200 S3/DMOM-600 shall be used only by trained operators. All circuit breakers under test shall be off-line and fully isolated.

### SERVICE AND REPAIR

- Do not install substitute parts or perform any unauthorized modification to any Auto-Ohm 200 S3/DMOM-200 S3/DMOM-600 test unit.
- Repairs must be performed only by Vanguard Instruments Company factory personnel or by an authorized repair service provider. Unauthorized modifications can cause safety hazards and will void the manufacturer's warranty.

### EQUIPMENT RATINGS

**IP Rating:** The enclosures for Auto-Ohm 200 S3, DMOM-200 S3, and DMOM-600 have an IP rating of 32.

**Pollution Degree:** The Auto-Ohm 200 S3, DMOM-200 S3, and DMOM-600 have a pollution rating of 2.

**Operating Voltage:** The Auto-Ohm 200 S3, DMOM-200 S3, and DMOM-600 are rated for use with an operating voltage of 120V or 240V, auto-ranging  $\pm 10\%$  of selected voltage.

**Power Cord:** The Auto-Ohm 200 S3, DMOM-200 S3, and DMOM-600 are supplied with a 16 AWG, 16A power cord with a NEMA 5-15P plug. Replacement cable shall have the same or better rating and is available through the manufacturer.

### VENTILATION REQUIREMENTS

The Auto-Ohm 200 S3, DMOM-200 S3, and DMOM-600 must be operated with the enclosure lid open.

### SAFETY SYMBOLS



Indicates that caution should be exercised



Indicates location of chassis ground terminal

### CLEANING

To clean the Auto-Ohm 200 S3, DMOM-200 S3, and DMOM-600:

- Disconnect all cables and turn the unit off.
- Use a soft, lint-free cloth to wipe all surfaces clean.
- Avoid getting moisture in openings and connectors.
- Don't use any cleaning products or compressed air.

## TABLE OF CONTENTS

CONVENTIONS USED IN THIS DOCUMENT .....	1
1.0 INTRODUCTION .....	2
1.1 Auto-Ohm 200 S3 General Description and Features .....	2
1.2 DMOM-200 S3 General Description and Features .....	4
1.3 DMOM-600 General Description and Features .....	6
1.4 Cables and Accessories .....	6
1.5 Auto-Ohm 200 S3 Technical Specifications .....	9
1.6 DMOM-200 S3 Technical Specifications .....	10
1.7 DMOM-600 Technical Specifications .....	11
1.8 Auto-Ohm 200 S3 Controls and Indicators .....	12
1.9 DMOM-200 S3 Controls and Indicators .....	13
1.10 DMOM-600 Controls and Indicators .....	14
2.0 PRE-TEST SETUP .....	15
2.1 Operating Voltages .....	15
2.2 LCD Screen Contrast Control .....	15
3.0 OPERATING PROCEDURES .....	16
3.1 Connection Diagrams .....	16
3.3 Setting the Interface Language .....	18
3.4 Testing Procedures .....	19
3.4.1. Entering Test Record Header Information .....	19
3.4.2. Performing a Test .....	22
3.4.3. Performing a Quick Test .....	33
3.5 Working With Test Records .....	37
3.5.1. Viewing the Contents of the Working Memory .....	37
3.5.2. Saving Test Results to a Test Record .....	39
3.5.3. Restoring a Test Record From Flash EEPROM .....	41
3.5.4. Restoring a Test Record From a USB Flash Drive .....	45
3.5.5. Copying Test Records to a USB Flash Drive .....	48
3.5.6. Viewing the Test Record Directory .....	51
3.5.7. Erasing Test Records from the Flash EEPROM .....	53
3.5.8. Erasing Test Records from a USB Flash Drive .....	58
4.0 Getting the Latest Firmware, Software, and Manuals .....	61

## LIST OF TABLES

Table 1. Auto-Ohm 200 S3 Technical Specifications.....	9
Table 2. DMOM-200 S3 Technical Specifications .....	10
Table 3. DMOM-600 Technical Specifications .....	11

## LIST OF FIGURES

Figure 1. Furnished Current and Sense Combination Cables .....	7
Figure 2. Furnished Current Cable and Sense Cables for DMOM-600 .....	7
Figure 3. Optional Cable with C-Clamp .....	8
Figure 4. Optional Hand Spike .....	8
Figure 5. Auto-Ohm 200 S3 Controls and Indicators .....	12
Figure 6. DMOM-200 S3 Controls and Indicators .....	13
Figure 7. DMOM-600 Controls and Indicators.....	14
Figure 8. Typical Auto-Ohm S3 Connection Diagram .....	16
Figure 9. Typical Auto-Ohm S3 Connection Diagram with Dual Ground Option.....	16
Figure 10. Sample DMOM-200 S3/DMOM-600 Printout.....	32
Figure 11. Sample DMOM-200 S3/DMOM-600 Printout (with Dual Ground Option) .....	32

## CONVENTIONS USED IN THIS DOCUMENT

This document uses the following conventions:

- The general term “Auto-Ohm S3” is used in this manual to refer to the Auto-Ohm 200 S3, the DMOM-200 S3, and the DMOM-600.
- A key, switch, or knob on the Auto-Ohm S3 is indicated as **[KEY]**, **[SWITCH]**, **[KNOB]**.
- Menu names are referenced as “MENU NAME”
- Auto-Ohm S3 screen output is shown as:

```

1. OPTION 1
2. OPTION 2
3. OPTION 3
4. OPTION 4
5. OPTION 5
    
```

- When instructions are provided, the menu item that should be selected is outlined with a rectangle as shown below (option 3 should be selected):

```

1. OPTION 1
2. OPTION 2
3. OPTION 3
4. OPTION 4
5. OPTION 5
    
```

- Warning messages are indicated as:



Warning message

**WARNING**

- Important notes are indicated as:



Note details

**NOTE**

## 1.0 INTRODUCTION

### 1.1 Auto-Ohm 200 S3 General Description and Features

The Auto-Ohm-200 S3 is Vanguard's fourth generation, microprocessor-based, true DC micro-ohmmeter. It is designed for testing EHV circuit-breaker contact resistances, bushing contact joints, welding joints, or for any low-resistance measuring application. This high current and very lightweight (16.8 lbs/ 7.6 Kg) micro-ohmmeter is designed to meet the IEEE C57.09-1999 (5.15) requirement for testing circuit breaker contact resistance.

The Auto-Ohm-200 S3 can accurately measure resistance values from 1 micro-ohm to 5 ohms. A 0.1 micro-ohm resolution is possible with current greater than 5A. The Auto-Ohm-200 S3 applies a selectable true DC test current from 1A to 200A to the resistance load to be tested. The Auto-Ohm-200 S3 controls the test current's rise and fall rates. The test current rise and fall rate can be selected from 5 seconds to 10 seconds. An "Auto Test" mode is also available and can be initiated simply by applying the sense cables' leads across the two points of interest in the current path. This feature is very convenient when measuring a sequence of several resistance values in a circuit breaker contact. The Auto-Ohm 200 S3 can also compare test results against preset limits and determine if a test passed or failed, and a "Pass" or "Fail" flag is displayed accordingly.

Since a true DC current (with controlled rise/fall time) is passed through the circuit breaker contact, no magnetic transient is induced into the breaker's current transformers. This feature greatly reduces the risk of inductively trip-ping a breaker control (bus differential relay).

With the Dual Ground option, the Auto-Ohm-200 S3 can also measure the circuit breaker contact resistance with both sides of the breaker bushing being grounded. When a test current is applied to a circuit breaker with both sides grounded, some of the test current flows through the safety ground cables. Using an external current sensor, the Auto-Ohm-200 S3 measures and eliminates this current from the total test current. The Auto-Ohm then calculates the actual resistance value of the circuit breaker.

The Auto-Ohm-200 S3 features a back-lit 128 x 64 pixel LCD screen that is viewable in both direct sunlight and low-light levels. The resistance readings are displayed on the LCD screen in micro-ohms or milliohms. The unit is operated via a convenient 44-key "QWERTY" keypad on the front panel. The Auto-Ohm 200 S3 can store 128 records of 64 readings internally, and up to 999 test records on an external USB Flash drive. Test header information (Company, Substation, circuit breaker ID's) can also be entered using the 44-key keypad and is stored with each test record.

Windows® based (XP/Vista/7) analysis software is provided with each unit and can be used to remotely control the Auto-Ohm 200 S3 via the RS-232C port. Using this software, the user can retrieve test records (from the unit's memory or a USB Flash drive), analyze test results, and print test results on a desktop printer. Test records can also be exported to PDF, Excel, and XML formats.

The Auto-Ohm-200 S3 is furnished with a 30-ft test (#1 AWG) cable set. A 15-ft test cable set is also available as an option. Test cables are terminated with heavy duty welding type clamps. The test current and voltage sense cables are isolated and fastened to the clamp jaws. This feature allows for a simple connection to the circuit breaker bushing. An optional voltage sense cable and probe can be used to measure resistance in small access locations. Optional heavy-duty, welding type C-clamps are also available allowing the user to connect the test leads to a wide variety of bushing sizes, bus-bars, or large conductors.

## 1.2 DMOM-200 S3 General Description and Features

The DMOM-200 S3 is Vanguard's fourth generation, microprocessor-based, true DC micro-ohmmeter. It is designed for testing EHV circuit-breaker contact resistances, bushing contact joints, welding joints, or for any low-resistance measuring application. This high current and very lightweight (19.8 lbs/ 8.9 Kg) micro-ohmmeter is designed to meet the IEEE C57.09-1999 (5.15) requirement for testing circuit breaker contact resistance.

The DMOM-200 S3 can accurately measure resistance values from 1 micro-ohm to 5 ohms. A 0.1 micro-ohm resolution is possible with current greater than 5A. The DMOM-200 S3 applies a selectable true DC test current from 1A to 200A to the resistance load to be tested. The DMOM-200 S3 controls the test current's rise and fall rates. The test current rise and fall rate can be selected from 5 seconds to 10 seconds. An "Auto Test" mode is also available and can be initiated simply by applying the sense cables' leads across the two points of interest in the current path. This feature is very convenient when measuring a sequence of several resistance values in a circuit breaker contact. The DMOM-200 S3 can also compare test results against preset limits and determine if a test passed or failed, and a "Pass" or "Fail" flag is displayed accordingly.

Since a true DC current (with controlled rise/fall time) is passed through the circuit breaker contact, no magnetic transient is induced into the breaker's current transformers. This feature greatly reduces the risk of inductively tripping a breaker control (bus differential relay).

With the Dual Ground option, the DMOM-200 S3 can also measure the circuit breaker contact resistance with both sides of the breaker bushing being grounded. When a test current is applied to a circuit breaker with both sides grounded, some of the test current flows through the safety ground cables. Using an external current sensor, the DMOM-200 S3 measures and eliminates this current from the total test current. The DMOM-200 S3 then calculates the actual resistance value of the circuit breaker.

The DMOM-200 S3 features a back-lit 128 x 64 pixel LCD screen that is viewable in both direct sunlight and low light levels. The resistance readings are displayed on the LCD screen in micro-ohms or milliohms. The unit is operated via a convenient 44-key "QWERTY" keypad on the front panel. The DMOM-200 S3 can store 128 records of 64 readings internally, and up 999 test records on an external USB Flash drive. Test header information (Company, Substation, circuit breaker ID's) can also be entered using the 44-key keypad and is stored with each test record. The DMOM-200 S3 also features a built-in 2.5" wide thermal printer that can be used to print test reports in the field.

Windows® based (XP/Vista/7) analysis software is provided with each unit and can be used to remotely control the DMOM-200 S3 via the RS-232C port. Using this software, the user can retrieve test records (from the unit's memory or a USB Flash drive), analyze test results, and print test results on a desktop printer. Test results can also be exported to PDF, Excel, and XML formats.



The DMOM-200 S3 is furnished with a 30-ft test cable set. A 15-ft test cable set is also available as an option. Test cables are terminated with heavy duty welding type clamps. The test current and voltage sense cables are isolated and fastened to the clamp jaws. This feature allows for a simple connection to the circuit breaker bushing. An optional voltage sense cable and probe can be used to measure resistance in small access locations. Optional heavy-duty, welding type C-clamps are also available allowing the user to connect the test leads to a wide variety of bushing sizes, bus-bars, or large conductors.

### 1.3 DMOM-600 General Description and Features

The DMOM-600 is specifically designed for testing EHV circuit-breaker contact resistances, bushing contact joints, welding joints, or for any low-resistance measuring application. This high current and very lightweight (33 lbs/ 15 Kg) micro-ohmmeter is designed to meet the IEEE C57.09-1999 (5.15) requirement for testing circuit breaker contact resistance.

The DMOM-600 can accurately measure resistance values from 1 micro-ohm to 450 milliohms. A 0.1 micro-ohm resolution is possible with current greater than 10A. The DMOM-600 applies a selectable true DC test current from 10A to 600A to the resistance load to be tested. The DMOM-600 controls the test current's rise and fall rates. The test current rise and fall rate can be selected from 5 seconds to 10 seconds. An "Auto Test" mode is also available and can be initiated simply by applying the sense cables' leads across the two points of interest in the current path. This feature is very convenient when measuring a sequence of several resistance values in a circuit breaker contact. The DMOM-600 can also compare test results against preset limits and determine if a test passed or failed, and a "Pass" or "Fail" flag is displayed accordingly.

Since a true DC current (with controlled rise/fall time) is passed through the circuit breaker contact, no magnetic transient is induced into the breaker's current transformers. This feature greatly reduces the risk of inductively tripping a breaker control (bus differential relay).

With the Dual Ground option, the DMOM-600 can also measure the circuit breaker contact resistance with both sides of the breaker bushing being grounded. When a test current is applied to a circuit breaker with both sides grounded, some of the test current flows through the safety ground cables. Using an external current sensor, the DMOM-600 measures and eliminates this current from the total test current. It then calculates the actual resistance value of the circuit breaker.

The DMOM-600 features a back-lit 128 x 64 pixel LCD screen that is viewable in both direct sunlight and low light levels. The resistance readings are displayed in a large font on the LCD screen in micro-ohms or milliohms. The unit is operated via a convenient 44-key "QWERTY" keypad on the front panel. The DMOM-600 can store 128 records of 64 readings internally, and up 999 test records on an external USB Flash drive. Test header information (Company, Substation, circuit breaker ID's) can also be entered using the 44-key keypad and is stored with each test record. The DMOM-600 also features a built-in 2.5" wide thermal printer that can be used to print test reports in the field.

Windows® based (XP/Vista/7) analysis software is provided with each unit. Using this software, the user can retrieve test records (from the unit's memory or a USB Flash drive), analyze test results, and print test results on a desktop printer. Test results can also be exported to PDF, Excel, and XML formats.

The DMOM-600 is furnished with a 15-ft (#1/0 AWG) test cable set. Custom test cable lengths are optionally available. Optional heavy-duty, welding type C-clamps are also available allowing the user to connect the test leads to a wide variety of bushing sizes, bus-bars, or large conductors.

### 1.4 Cables and Accessories

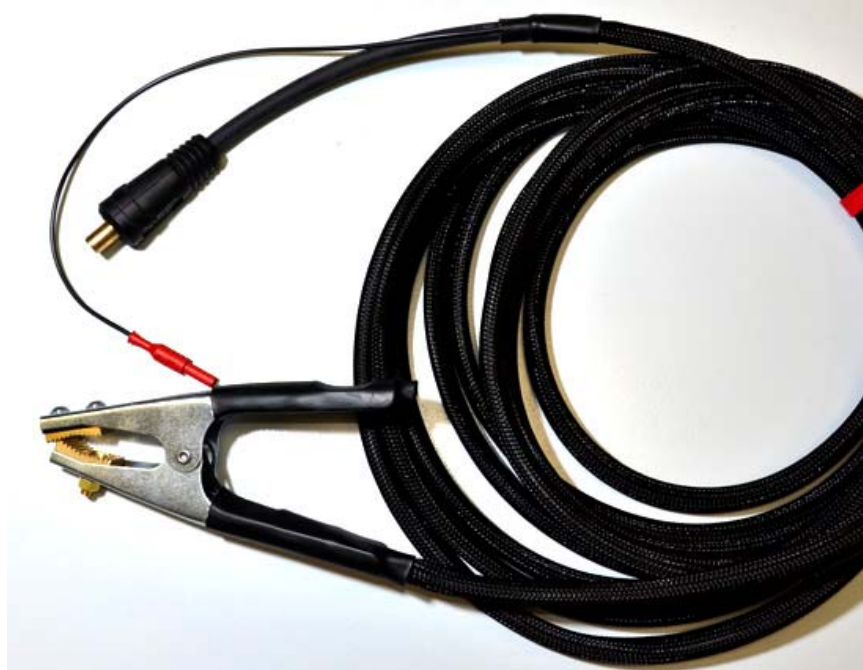

**Figure 1. Furnished Current and Sense Combination Cables (P/N 8000-0076)  
(Auto-Ohm 200 S3 and DMOM-200 S3)**



**Figure 2. Furnished Current Cable (P/N 8000-0072) and Sense Cables (P/N 8000-0073) for DMOM-600**



Figure 3. Optional Cable with C-Clamp



Figure 4. Optional Hand Spike

## 1.5 Auto-Ohm 200 S3 Technical Specifications

**Table 1. Auto-Ohm 200 S3 Technical Specifications**

<b>TYPE</b>	Portable Micro-Ohmmeter
<b>PHYSICAL SPECIFICATIONS</b>	17" W x 7" H x 13" D (43.2cm x 17.8cm x 33cm); Weight: 16.8 lbs (7.6 Kg)
<b>INPUT POWER</b>	100-240 Vac, 14A, 50/60Hz
<b>RESISTANCE READING RANGE</b>	1 micro-ohm to 10 milliohms at 200 A (0.1 micro-ohm resolution) 1 micro-ohm to 5 ohms at 1A
<b>ACCURACY</b>	1A to 4.99A: 1% ±10 micro-ohms 5A to 9.99A: 1% ±2 micro-ohms 10A to 200A: 1% ±1 micro-ohm
<b>TEST CURRENT RANGE</b>	1 Ampere to 200 Amperes (selectable in 1A steps); Thermally protected DC power supply
<b>DISPLAY</b>	Backlit LCD (128 x 64 pixels), viewable in direct sunlight and low light levels
<b>KEYPAD</b>	Rugged, 44key "QWERTY" membrane keypad
<b>INTERNAL TEST RECORD STORAGE</b>	128 test records. Each record can contain up to 64 readings
<b>EXTERNAL TEST RECORD STORAGE</b>	Up to 999 test records on external USB Flash drive.
<b>COMPUTER INTERFACE</b>	RS-232C
<b>PC SOFTWARE</b>	Windows XP/Vista/7 Analysis Software (included with purchase)
<b>SAFETY</b>	Designed to meet IEC 61010 (1995), UL 61010a, and CASC22.2 standards
<b>ENVIRONMENT</b>	Operating: 10°C to 50°C (15°F to +122°F) Storage: 30°C to 70°C (22°F to +158°F)
<b>HUMIDITY (MAX)</b>	90% RH @ 40° C (104° F) non-condensing
<b>ALTITUDE (MAX)</b>	2000m (6562 ft) to full safety specifications
<b>CABLES</b>	30 ft (9.1 m), #1 AWG test cables, power cord, ground cable
<b>OPTIONS</b>	Shipping case, 15 ft test cables, C-Clamp set, Hand Spike Set, Dual Ground option
<b>WARRANTY</b>	One year on parts and labor



**NOTE**

The above specifications are valid at nominal operating voltage and at a temperature of 25°C (77°F). Specifications may change without prior notice.

## 1.6 DMOM-200 S3 Technical Specifications

**Table 2. DMOM-200 S3 Technical Specifications**

<b>TYPE</b>	Portable Micro-Ohmmeter
<b>PHYSICAL SPECIFICATIONS</b>	18" W x 7" H x 15" D (45.7cm x 17.8cm x 38.1cm); Weight: 19.8 lbs (8.9 Kg)
<b>INPUT POWER</b>	100-240 Vac, 14A, 50/60Hz
<b>RESISTANCE READING RANGE</b>	10 milliohms at 200 A to 5 ohms at 1A
<b>ACCURACY</b>	1A to 4.99A: 1% $\pm$ 10 micro-ohms 5A to 9.99A: 1% $\pm$ 2 micro-ohms 10A to 200A: 1% $\pm$ 1 micro-ohm
<b>TEST CURRENT RANGE</b>	1 Ampere to 200 Amperes (selectable in 1A steps); Thermally protected DC power supply
<b>DISPLAY</b>	Backlit LCD (128 x 64 pixels), viewable in direct sunlight and low light levels
<b>KEYPAD</b>	Rugged, 44key "QWERTY" membrane keypad
<b>INTERNAL TEST RECORD STORAGE</b>	128 test records. Each record can contain up to 64 readings
<b>EXTERNAL TEST RECORD STORAGE</b>	Up to 999 test records on external USB Flash drive.
<b>COMPUTER INTERFACE</b>	RS-232C
<b>PRINTER</b>	Built-in 2.5" wide thermal printer
<b>PC SOFTWARE</b>	Windows XP/Vista/7 Analysis Software (included with purchase)
<b>SAFETY</b>	Designed to meet IEC 61010 (1995), UL 61010a, and CASC22.2 standards
<b>ENVIRONMENT</b>	Operating: 10°C to 50°C (15°F to +122°F) Storage: 30°C to 70°C (22°F to +158°F)
<b>HUMIDITY (MAX)</b>	90% RH @ 40° C (104° F) non-condensing
<b>ALTITUDE (MAX)</b>	2000m (6562 ft) to full safety specifications
<b>CABLES</b>	30 ft (9.1 m), #1 AWG test cables, power cord, ground cable
<b>OPTIONS</b>	Shipping case, 15 ft test cables, C-Clamp set, Hand Spike Set, Dual Ground option
<b>WARRANTY</b>	One year on parts and labor



**NOTE**

The above specifications are valid at nominal operating voltage and at a temperature of 25°C (77°F). Specifications may change without prior notice.



## 1.7 DMOM-600 Technical Specifications

**Table 3. DMOM-600 Technical Specifications**

<b>TYPE</b>	Portable Micro-Ohmmeter
<b>PHYSICAL SPECIFICATIONS</b>	16.8" W x 12.6" H x 12" D (42.7cm x 32cm x 30.5cm); Weight: 33 lbs (15 Kg)
<b>INPUT POWER</b>	100-120 Vac, 20A, 50/60 Hz – Up to 300A load 220-240 Vac, 20A, 50/60Hz – Up to 600A load
<b>RESISTANCE READING RANGE</b>	1 milliohm at 600A to 450 milliohms at 10A
<b>ACCURACY</b>	10A to 49.9A: 1% ±2 micro-ohms 50A to 600A: 1% ±1 micro-ohm
<b>TEST CURRENT RANGE</b>	10 Amperes to 600 Amperes (selectable in 1A steps) Thermally protected DC power supply
<b>DISPLAY</b>	Backlit LCD (128 x 64 pixels), viewable in direct sunlight and low light levels
<b>KEYPAD</b>	Rugged, 44key "QWERTY" membrane keypad
<b>INTERNAL TEST RECORD STORAGE</b>	128 test records. Each record can contain up to 64 readings
<b>EXTERNAL TEST RECORD STORAGE</b>	Up to 999 test records on external USB Flash drive.
<b>COMPUTER INTERFACE</b>	RS-232C
<b>PRINTER</b>	Built-in 2.5" wide thermal printer
<b>PC SOFTWARE</b>	Windows XP/Vista/7 Analysis Software (included with purchase)
<b>SAFETY</b>	Designed to meet IEC 61010 (1995), UL 61010a, and CASC22.2 standards
<b>ENVIRONMENT</b>	Operating: 10°C to 50°C (15°F to +122°F) Storage: 30°C to 70°C (22°F to +158°F)
<b>HUMIDITY (MAX)</b>	90% RH @ 40° C (104° F) non-condensing
<b>ALTITUDE (MAX)</b>	2000m (6562 ft) to full safety specifications
<b>CABLES</b>	15 ft (4.6 m), #1/0 AWG test cables, power cord, ground cable
<b>OPTIONS</b>	Shipping case, C-Clamp set, Hand Spike Set, Dual Ground option
<b>WARRANTY</b>	One year on parts and labor



**NOTE**

The above specifications are valid at nominal operating voltage and at a temperature of 25°C (77°F). Specifications may change without prior notice.

## 1.8 Auto-Ohm 200 S3 Controls and Indicators

The Auto-Ohm 200 S3's controls and indicators are shown in Figure 5. The purpose of the controls and indicators may seem obvious, but users should familiarize themselves with them before using the Auto-Ohm 200 S3. Accidental misuse of the controls will usually cause no serious harm. Users should also familiarize themselves with the safety summary information found on the front page of this User's Manual.

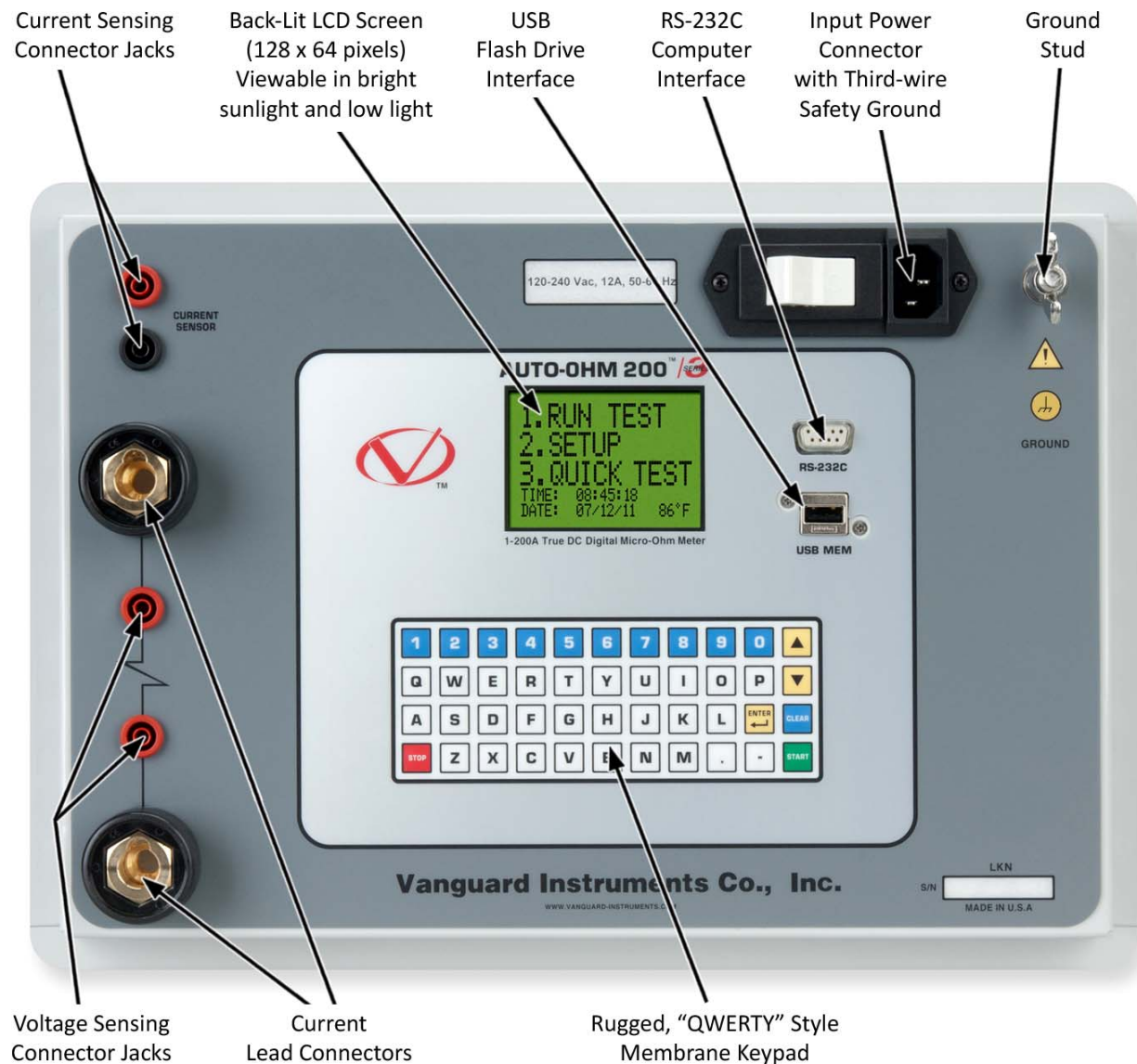

Figure 5. Auto-Ohm 200 S3 Controls and Indicators



### 1.9 DMOM-200 S3 Controls and Indicators

The DMOM-200 S3's controls and indicators are shown in Figure 6. The purpose of the controls and indicators may seem obvious, but users should familiarize themselves with them before using the DMOM-200 S3. Accidental misuse of the controls will usually cause no serious harm. Users should also familiarize themselves with the safety summary information found on the front page of this User's Manual.

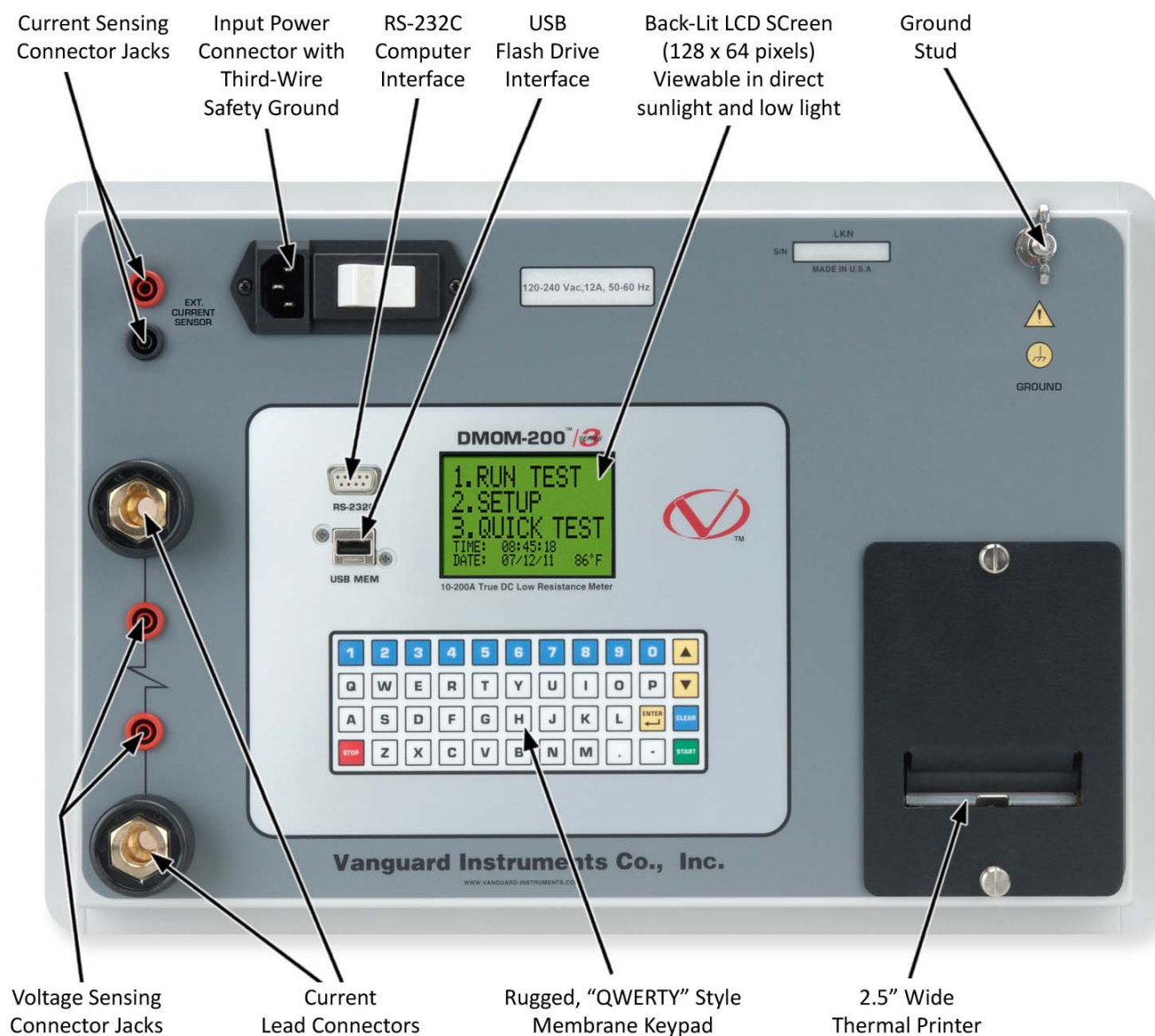

Figure 6. DMOM-200 S3 Controls and Indicators

## 1.10 DMOM-600 Controls and Indicators

The DMOM-600's controls and indicators are shown in Figure 7. The purpose of the controls and indicators may seem obvious, but users should familiarize themselves with them before using the DMOM-600. Accidental misuse of the controls will usually cause no serious harm. Users should also familiarize themselves with the safety summary information found on the front page of this User's Manual.

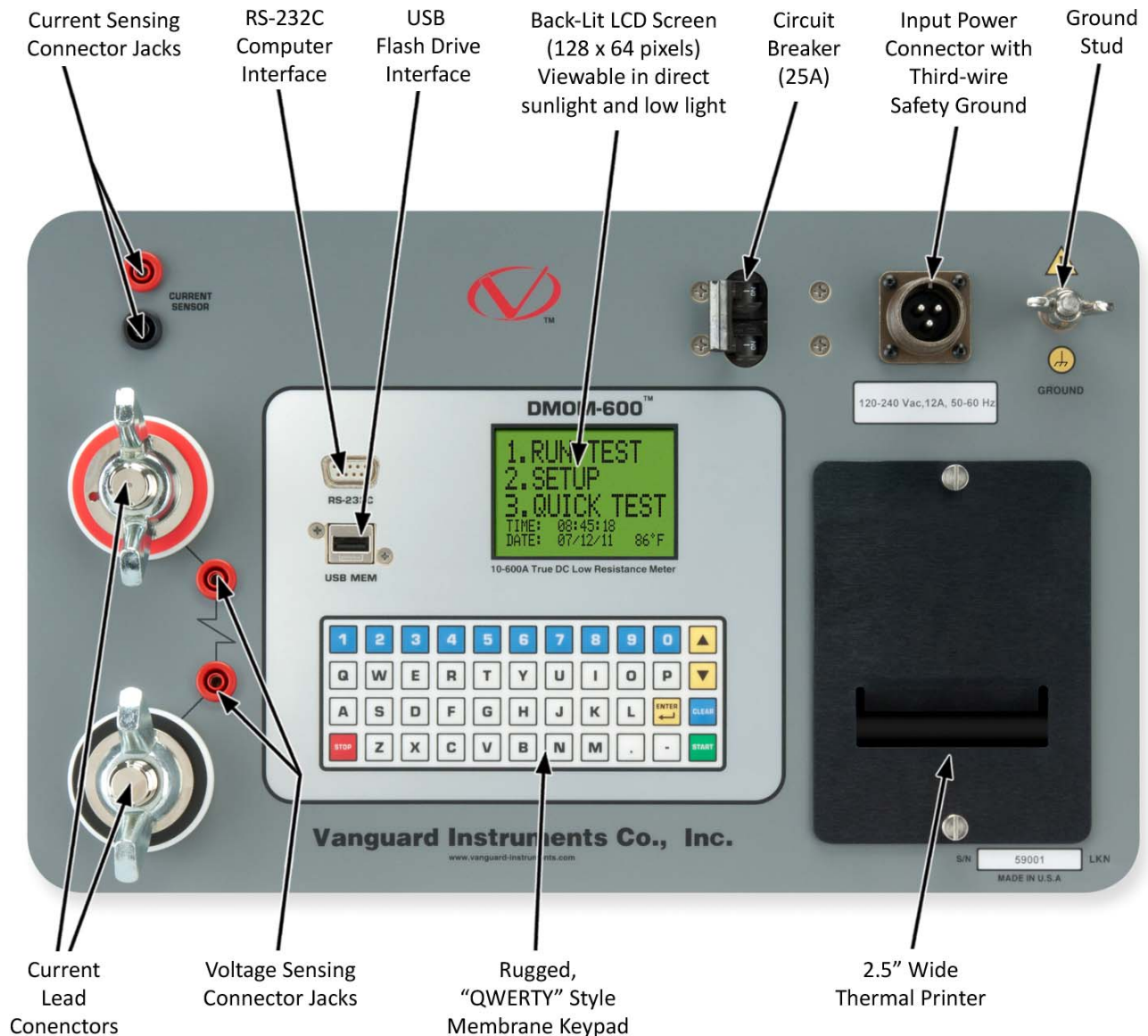

Figure 7. DMOM-600 Controls and Indicators

## 2.0 PRE-TEST SETUP

### 2.1 Operating Voltages

The Auto-ohm 200 S3, DMOM-200 S3, and DMOM-600 operate on voltages between 120-240 Vac, 50/60 Hz.

### 2.2 LCD Screen Contrast Control

To increase the LCD screen contrast, press and hold the **[^]** key for two seconds. Release the button when the desired contrast level has been reached.

To decrease the LCD screen contrast, press and hold the **[v]** key for two seconds. Release the button when the desired contrast level has been reached.

### 2.3 Safety Ground

Always ground the Auto-Ohm S3 to the substation ground before connecting test cables to the circuit breaker.

### 2.4 Printer Paper (DMOM-200 S3 and DMOM-600 Only)

The DMOM-200 S3 and DMOM-600's built-in thermal printer uses 2.5-inch wide thermal paper for printing test results. To maintain the highest print quality and to avoid paper jams, the use of thermal paper supplied by Vanguard Instruments Company is highly recommended. Additional paper can be ordered from the following sources:

#### **Vanguard Instruments Co, Inc.**

1520 S. Hellman Avenue  
Ontario, CA 91761  
Tel: 909-923-9390  
Fax: 909-923-9391  
Part Number: VIC TP-3 paper

#### **BG Instrument Co.**

13607 E. Trent Avenue  
Spokane, WA 99216  
Tel: 509-893-9881  
Fax: 509-893-9803  
Part Number: VIC TP-3 paper

### 3.0 OPERATING PROCEDURES

#### 3.1 Connection Diagrams

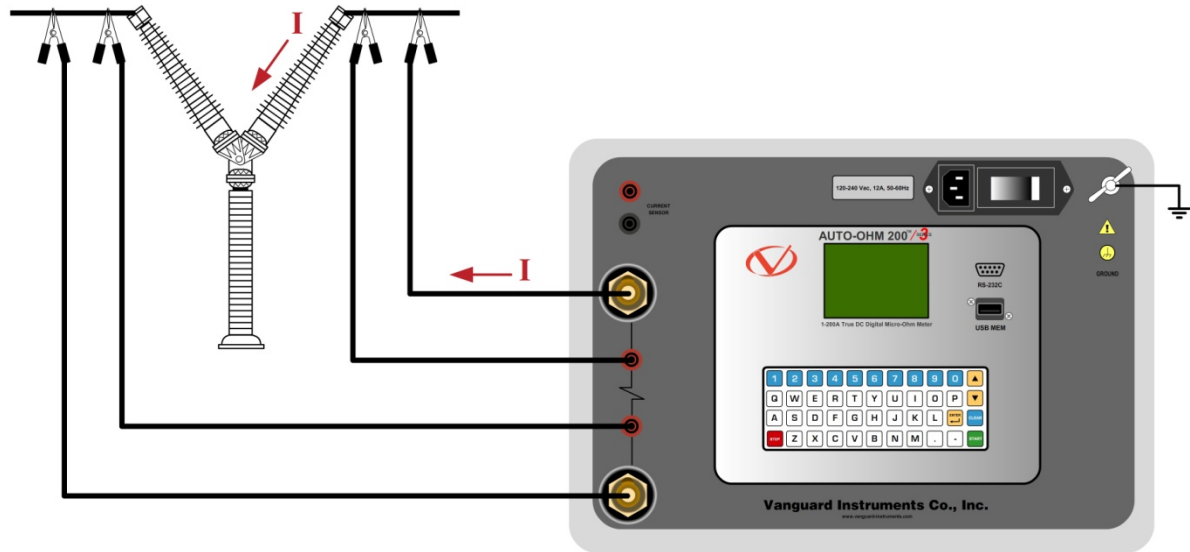

Figure 8. Typical Auto-Ohm S3 Connection Diagram

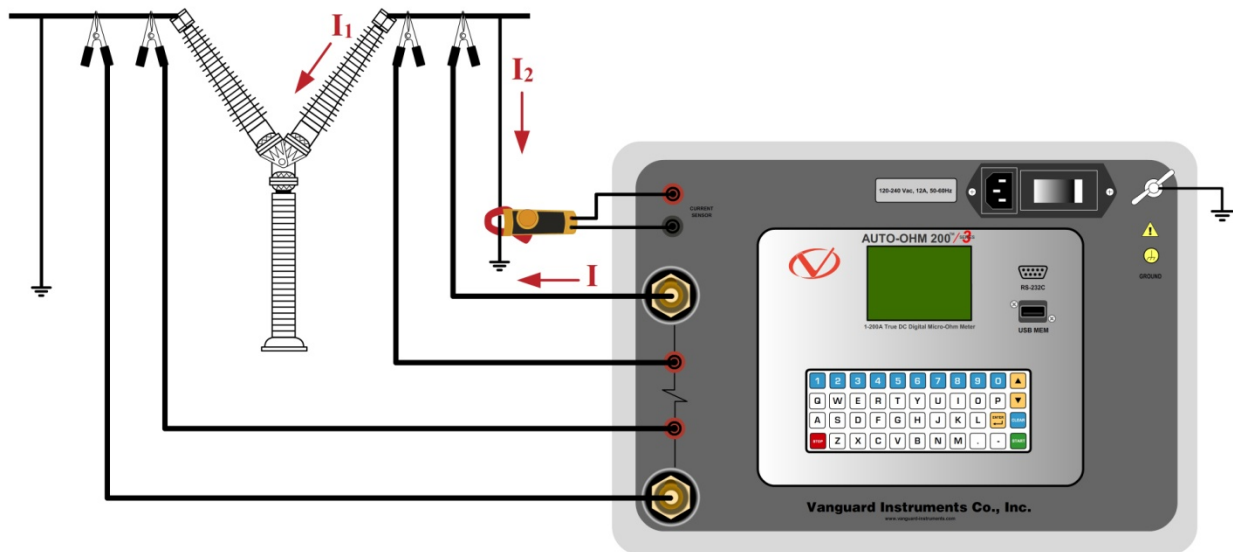
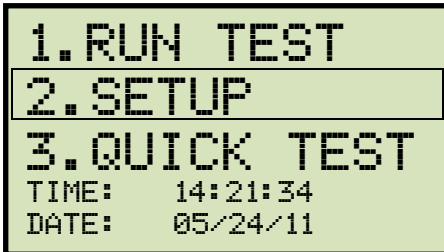

Figure 9. Typical Auto-Ohm S3 Connection Diagram with Dual Ground Option

### 3.2 Setting the Date and Time

To set the date and time:

- a. Start from the "START-UP" menu:



Press the **[2]** key (*SETUP*).

- b. The following screen will be displayed:

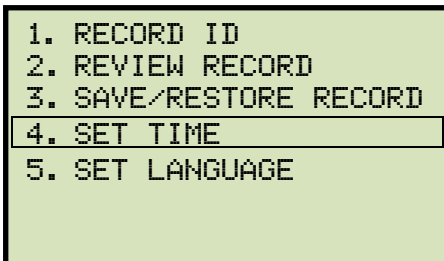

Press the **[4]** key (*SET TIME*)

- c. The following screen will be displayed:



Type in the date using the keypad. The following screen will be displayed:



Enter the time using the alpha-numeric keypad. When the time has been entered, you will be immediately returned to the "START-UP" menu.

### 3.3 Setting the Interface Language

Follow the steps below to set the interface language (English, Spanish, or Turkish):

- a. Start from the "START-UP" menu:



Press the **[2]** key (*SETUP*).

- b. The following screen will be displayed:

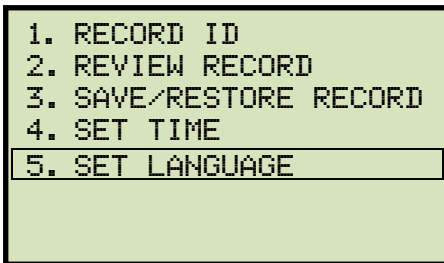

Press the **[5]** key (*SET LANGUAGE*).

- c. The following screen will be displayed:

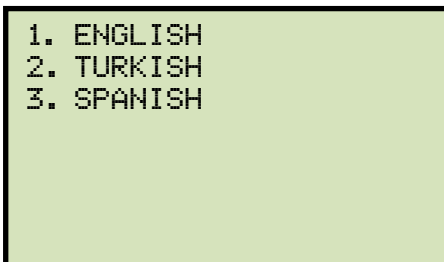

Select the preferred interface language by pressing the corresponding key on the keypad (**[1]**, **[2]**, or **[3]**). The interface language will be set and a confirmation screen will be displayed as shown below:



Press any key to return to the "START-UP" menu.

### 3.4 Testing Procedures

#### 3.4.1. Entering Test Record Header Information

You can enter the test record header information before performing tests. The record header includes identifying information such as the company, station, circuit, manufacturer, etc. Once the header information has been set, it will apply to all subsequent test records. Follow the steps below to enter the test header information:

- a. Start from the "START-UP" menu:

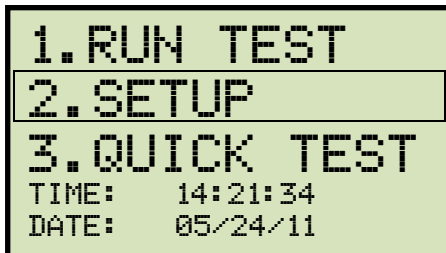

Press the **[2]** key (*SETUP*).

- b. The following screen will be displayed:

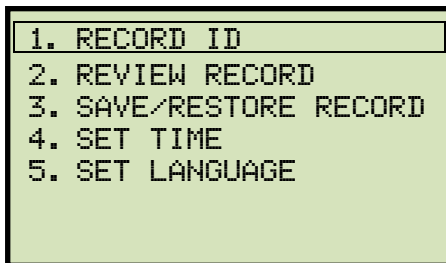

Press the **[1]** key (*RECORD ID*).

- c. The following screen will be displayed:

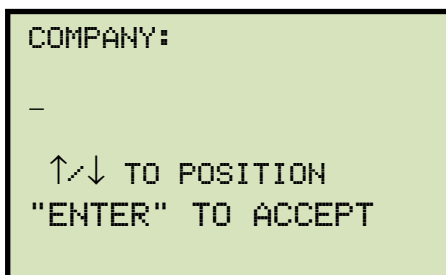

Type the company name using the keypad. Press the **[ENTER]** key when you are done typing the company name.

- d. The following screen will be displayed:

```
STATION:  
-  
  
↑/↓ TO POSITION  
"ENTER" TO ACCEPT
```

Type the station name using the keypad and then press the **[ENTER]** key.

- e. The following screen will be displayed:

```
CIRCUIT:  
-  
  
↑/↓ TO POSITION  
"ENTER" TO ACCEPT
```

Type the circuit information using the keypad and then press the **[ENTER]** key.

- f. The following screen will be displayed:

```
MANUFACTURER:  
-  
  
↑/↓ TO POSITION  
"ENTER" TO ACCEPT
```

Type the manufacturer name using the keypad and then press the **[ENTER]** key.



- g. The following screen will be displayed:

```
MODEL:
-
↑/↓ TO POSITION
"ENTER" TO ACCEPT
```

Type the circuit breaker's model information using the keypad and then press the **[ENTER]** key.

- h. The following screen will be displayed:

```
SERIAL NUMBER:
-
↑/↓ TO POSITION
"ENTER" TO ACCEPT
```

Type the circuit breaker's serial number using the keypad and then press the **[ENTER]** key.

- i. The following screen will be displayed:

```
KVA RATING:
-
↑/↓ TO POSITION
"ENTER" TO ACCEPT
```

Type the circuit breaker's KVA rating using the keypad and then press the **[ENTER]** key.

- j. The following screen will be displayed:

```
OPERATOR:
-
↑/↓ TO POSITION
"ENTER" TO ACCEPT
```

Type the operator's name using the keypad and then press the **[ENTER]** key. All header information will be saved, and you will be returned to the "START-UP" menu.

### 3.4.2. Performing a Test

Follow the steps below to perform a test:

- a. Start from the "START-UP" menu:

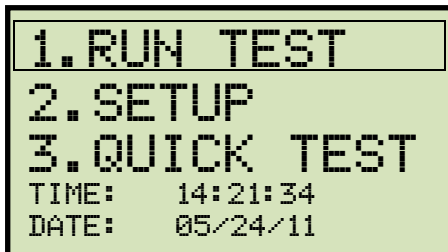

Press the **[1]** key (*RUN TEST*).

- b. The following screen will be displayed:

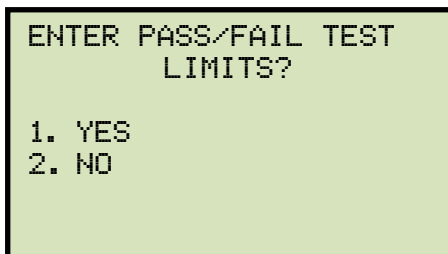

1. YES

Press the **[1]** key (*YES*) if you would like to set the passing resistance range for a test. The following screen will be displayed:

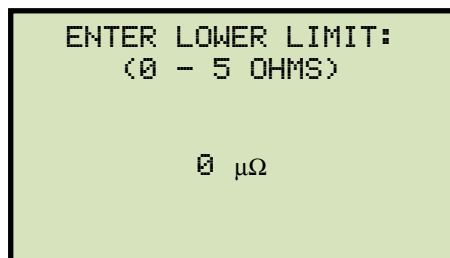

Enter the lower resistance limit for a passing test using the keypad. The screen will be updated as shown below:

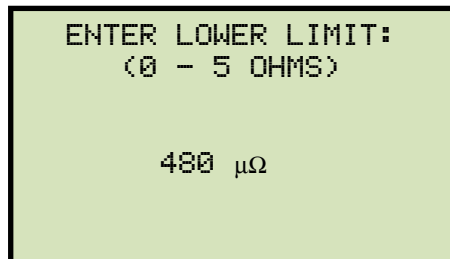

Press the **[ENTER]** key. The following screen will be displayed:

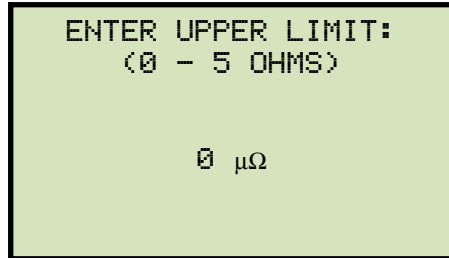

Enter the upper resistance limit for a passing test using the keypad. The screen will be updated as shown below:

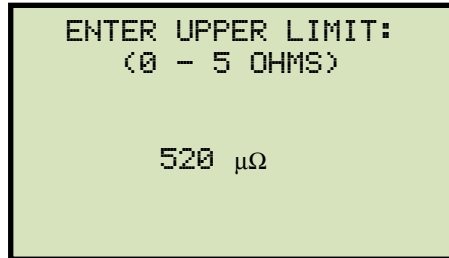

Press the **[ENTER]** key. **Continue to step c.**

2. *NO*

Press the **[2]** key (*NO*) if you do not want to enter the passing resistance range for a test. **Continue to step c.**



NOTES

If using an Auto-Ohm 200 S3 with the Dual Ground option, the following screen will be displayed before the screen shown in step c:

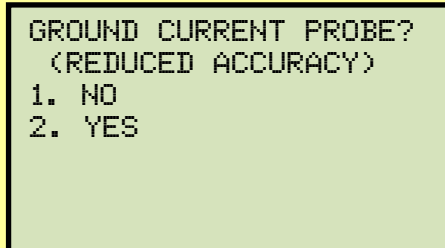

1. *NO*

Press the **[1]** key (*NO*) if you are not using a current probe and do not want to use the Dual Ground option. **Continue to step c.**

2. *YES*

Press the **[2]** key (*YES*) if you have connected an external current probe and would like to use the Dual Ground option. The following screen will be displayed:

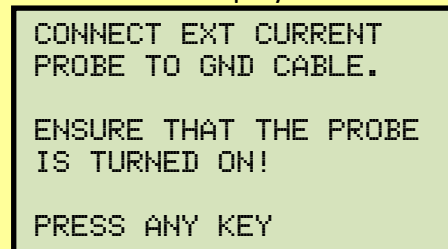

Connect the external current probe to the ground cable and then turn on the probe. **Press any key and continue to step c.**

- c. The following screen will be displayed:

```

1. NORMAL TEST
2. AUTOMATIC TEST

```

The Auto-Ohm 200 S3 provides a convenient automatic test mode that can be used to perform multiple tests without having to restart each test manually. When performing an automatic test, the Auto-Ohm will sense when cables are disconnected and re-connected and will initiate the test 2 seconds after sensing a re-connection.

Press the **[1]** key (*NORMAL TEST*) if you would like to perform a normal test. **Continue to step d.**

Press the **[2]** key (*AUTOMATIC TEST*) if you would like to perform an automatic test. **Continue to step d.**

- d. The following screen will be displayed:

#### Auto-Ohm 200 S3

```

SELECT TEST CURRENT:
1. 10A
2. 25A
3. 50A
4. 100A
5. 200A
6. CUSTOM

```

#### DMOM-600

```

SELECT TEST CURRENT:
1. 10A      2. 25A
3. 50A      4. 100A
5. 200A     6. 400A
7. 600A
8. CUSTOM

```

Select the test current by pressing the corresponding numeric key on the keypad. If the test current you would like to use is not listed, press the **[6]** key (*CUSTOM*) and then enter a value from 1A to 200A for the Auto-Ohm 200 S3/DMOM-200 S3 or 10 A to 600A for the DMOM-600.



#### NOTE

When using a DMOM-600 with input power of 100-120 Vac, the maximum recommended test current is 300A.

If you had selected the normal test mode, **continue to step e.**

If you had selected the automatic test mode, **continue to step f.**



#### NOTE

For an automatic test, the burn-in time is 5 seconds and cannot be changed.

e. The following screen will be displayed:

```

SELECT BURN-IN TIME:
1. 5 SEC
2. 10 SEC
3. 20 SEC
4. 30 SEC
5. 1 MIN   6. 2 MIN
7. 5 MIN   8. CONT.
    
```

Select the burn-in time by pressing the corresponding numeric key on the keypad.



Option **[8]** (*CONT.*) will run the test continuously.

**NOTE**

f. The following screen will be displayed:

```

SELECT RAMP TIME:
1. 5 SEC
2. 10 SEC
3. 20 SEC
4. 30 SEC
    
```

Select the ramp time by pressing the corresponding numeric key on the keypad.



The ramp time is the time to raise the current from 0A to the test current and also the time to lower the current from the test current to 0A.

**NOTE**

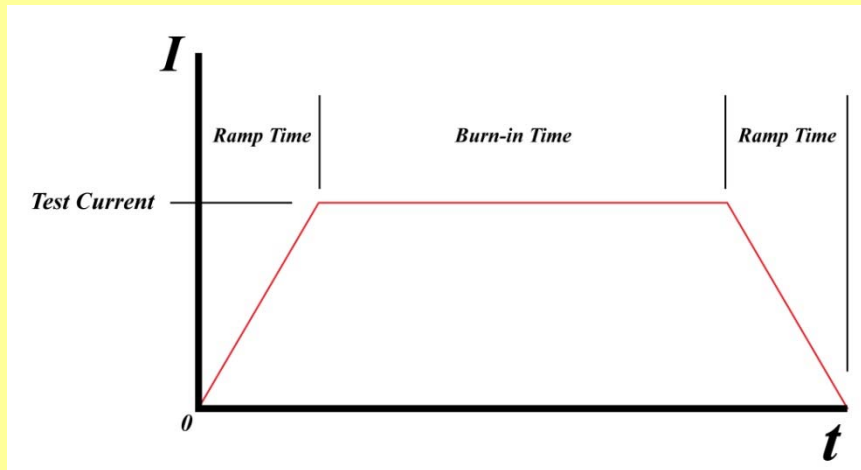

- g. The test parameters summary screen will be displayed as shown below:

```
TEST PARAMETERS
CURRENT: 50 AMPS
BURN-IN: AUTO
RAMP:    5 SEC
"START" TO RUN TEST
```

Press the **[START]** key to start the test.

- h. The following screen will be displayed temporarily:

```
AUTO TEST MODE
```

The screen will be updated as shown below while the current is being ramped up:

```
RAMPING CURRENT
12.30A  27%
TEST IN PROGRESS...
```

Once the current is ramped up to the selected test current, the initial test results will be displayed and the burn-in sequence will be initiated. The following screen will be displayed if the continuous burn-in time was NOT selected in step e:

```
BURNING IN: 04
497  $\mu\Omega$ 
50.01 A
TEST IN PROGRESS...
```



## NOTE

If the continuous burn-in option was selected in step e, the following screen will be displayed:



The unit will continue measuring the resistance and current and will display the values on the screen. To stop running the test, press the **[STOP]** key.

- i. The current will then be ramped down and then the final test results will be displayed as shown below:

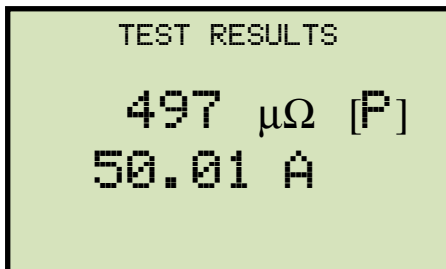

## NOTES

- A Pass/Fail ([P] or [F]) will be displayed if you had entered a passing resistance range in step b.
- If you had selected the automatic test mode in step c, you can now disconnect the cables and re-connect them as needed. A test will be initiated automatically 2 seconds after the re-connection is sensed.
- If the Dual Ground option was used, the ground current will also be displayed as shown below:

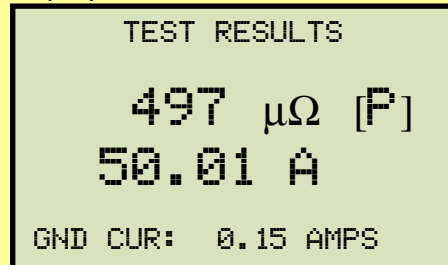

Press the **[STOP]** key to continue.

If you had selected the normal test option, **continue to step j.**

If you had selected the automatic test option, **continue to step k.**

j. The following screen will be displayed:

#### Auto-Ohm 200 S3

```

KEEP THIS READING?
1. YES
2. NO
  
```

Press the **[1]** key (YES) to save the reading.

#### DMOM-200 S3/DMOM-600

```

PRINT TEST RESULTS?
1. YES
2. NO
  
```

Press the **[1]** key (YES) to print the test results on the unit's built-in thermal printer (sample test results printouts are shown in Figure 10 and Figure 11). The following screen will be displayed:

```

KEEP THIS READING?
1. YES
2. NO
  
```

Press the **[1]** key (YES) to save the reading.



#### NOTES

If you had saved a test reading before the current test, the data will still be in the unit's working memory. The following screen will be displayed:

```

PREVIOUS DATA IN BUF
1. APPEND PREV DATA
2. CLEAR PREV DATA
3. SAVE PREV DATA AND
   START NEW RECORD
  
```

#### 3. APPEND PREV DATA

Press the **[1]** key (APPEND PREV DATA) to append the current test reading to the previous test record.

#### 4. CLEAR PREV DATA

Press the **[2]** key (CLEAR PREV DATA) to erase the previous reading from the test record and replace it in the working memory with the current test reading.

#### 5. SAVE PREV DATA AND START NEW RECORD

Press the **[3]** key (SAVE PREV DATA AND START NEW RECORD) to save the previous test reading in a test record and then create a new test



record for the current reading.

The following screen will be displayed:

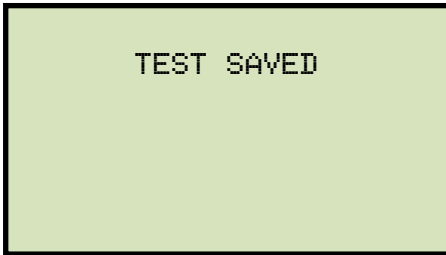

Press any key to continue.

The following screen will be displayed:

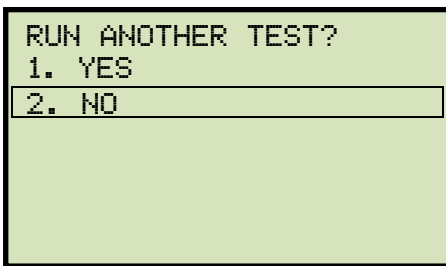

Press the **[2]** key (*NO*).

The following screen will be displayed:

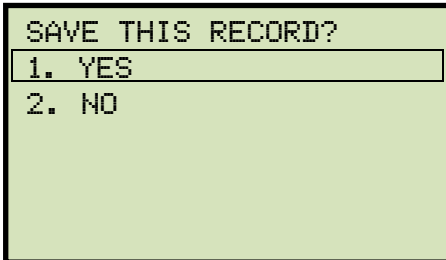

Press the **[1]** key (*YES*) to save the test record.

The following screen will be displayed:

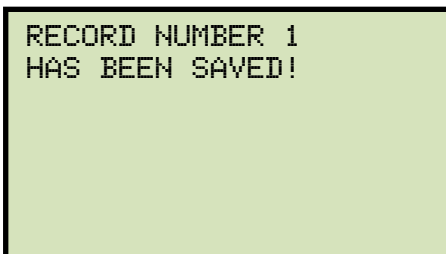

If a USB flash drive is connected to the unit, the following screen will be displayed instead:

**NOTES**

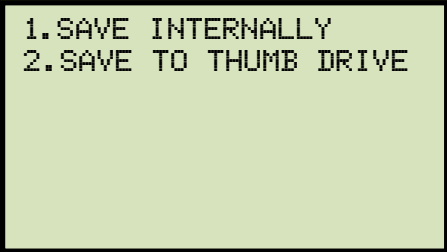

```
1. SAVE INTERNALLY
2. SAVE TO THUMB DRIVE
```

1. *SAVE INTERNALLY*

Press the **[1]** key (*SAVE INTERNALLY*) to save the test record to the unit's Flash EEPROM. The following screen will be displayed:

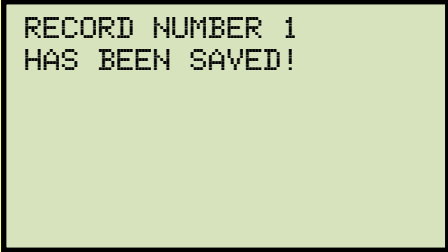

```
RECORD NUMBER 1
HAS BEEN SAVED!
```

2. *SAVE TO THUMB DRIVE*

Press the **[2]** key (*SAVE TO THUMB DRIVE*) to save the test record to the connected USB Flash drive. The following screen will be displayed:



```
REC_000 SAVED TO
THUMB DRIVE
```

Press any key to return to the "START-UP" menu.

k. The following screen will be displayed:



```
SAVE THIS RECORD?
```

```
1. YES
```

```
2. NO
```

Press the **[1]** key (*YES*) to save the test record.

The following screen will be displayed:

```
RECORD NUMBER 1  
HAS BEEN SAVED!
```

**NOTES**

If a USB flash drive is connected to the unit, the following screen will be displayed instead:

```
1. SAVE INTERNALLY  
2. SAVE TO THUMB DRIVE
```

*1. SAVE INTERNALLY*

Press the **[1]** key (*SAVE INTERNALLY*) to save the test record to the unit's Flash EEPROM. The following screen will be displayed:

```
RECORD NUMBER 1  
HAS BEEN SAVED!
```

*2. SAVE TO THUMB DRIVE*

Press the **[2]** key (*SAVE TO THUMB DRIVE*) to save the test record to the connected USB Flash drive. The following screen will be displayed:

```
REC_000 SAVED TO  
THUMB DRIVE
```

Press any key to return to the "START-UP" menu.

TEST RESULTS	
DATE:08/20/11	TIME:08:38:10
COMPANY: STATION: CIRCUIT: MFR: MODEL: S/N: KVA RATING: OPERATOR:	
TEST NUMBER: 1 TEST CURRENT: 100 AMPS RAMP TIME: 5 Seconds BURN-IN TIME: 5 Seconds	
RESULTS: CURRENT: 100.00 AMPS RESISTANCE: 100 uOhms [P]	
LOWER RES LIMIT: 95 uOhms UPPER RES LIMIT: 105 uOhms	
NOTES: _____	
DATE:08/20/11	TIME:08:38:10

Figure 10. Sample DMOM-200 S3/DMOM-600 Printout

REC NUMBER 15	
TEST RESULTS	
DATE:07/18/11	TIME:10:07:05
COMPANY: STATION: CIRCUIT: MFR: MODEL: S/N: KVA RATING: OPERATOR:	
TEST NUMBER: 1 TEST CURRENT: 10 AMPS RAMP TIME: 5 Seconds BURN-IN TIME: 5 Seconds	
RESULTS: CURRENT: 10.00 AMPS RESISTANCE: 56 uOhms GND CURRENT: 0.12 AMPS	
NOTES: _____	

Figure 11. Sample DMOM-200 S3/DMOM-600 Printout (with Dual Ground Option)

### 3.4.3. Performing a Quick Test

A quick test can be performed without having to enter the test current, the burn-in time, and the ramp time. For a quick test, a current of 100A is used, and the burn-in time and ramp time are both set to 5 seconds. The Quick Test mode should not be used if the circuit breaker is connected to dual grounds (if the unit has the Dual Ground option).



The Quick Test mode should not be used if the circuit breaker is connected to dual grounds because the Auto-Ohm will not monitor the external current probe current.

#### NOTE

Use the steps below to perform a quick test:

- a. Start from the "START-UP" menu:

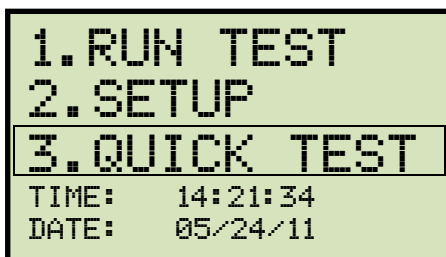

Press the **[3]** key (*QUICK TEST*)

- b. The following screen will be displayed

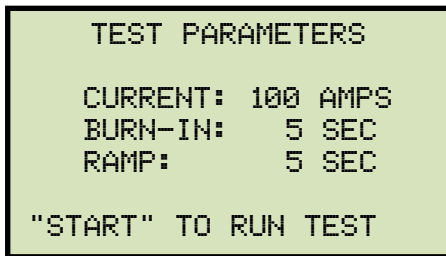

Press the **[START]** key.

- c. The unit will start ramping up the current to 100A. The following screen will be displayed:

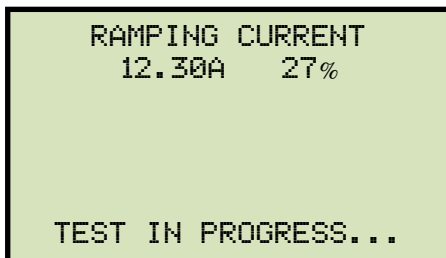

Once the current has reached 100A, the initial test results will be displayed and the burn-in sequence will be initiated. The following screen will be displayed:

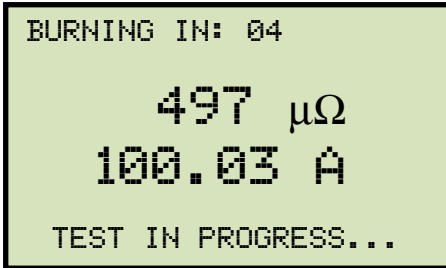

The current will then be ramped down and then the final test results will be displayed as shown below:



Press any key to continue.

- d. The following screen will be displayed:

**Auto-Ohm 200 S3**

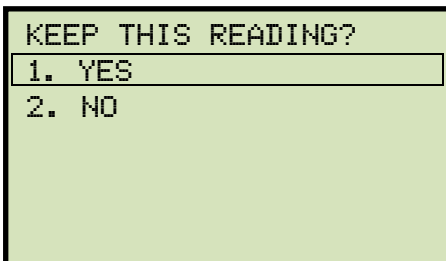

Press the **[1]** key (YES) to save the reading.

**DMOM-200 S3/DMOM-600**

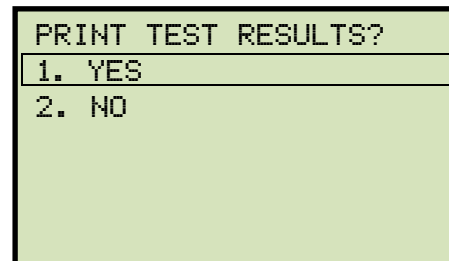

Press the **[1]** key (YES) to print the test results on the unit's built-in thermal printer. The following screen will be displayed:

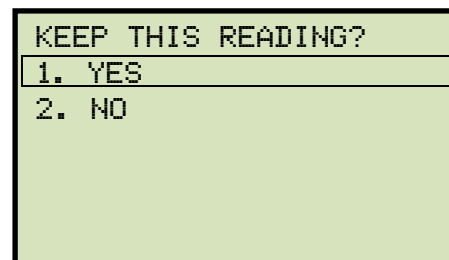

Press the **[1]** key (YES) to save the reading.

- e. The following screen will be displayed:

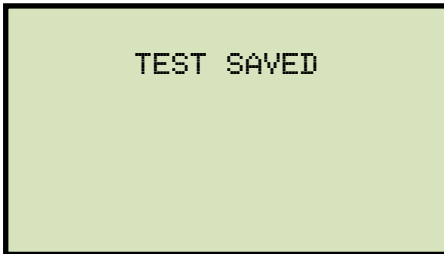

Press any key to continue.

- f. The following screen will be displayed:

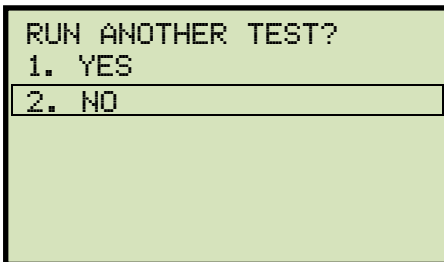

Press the **[2]** key (*NO*).

- g. The following screen will be displayed:

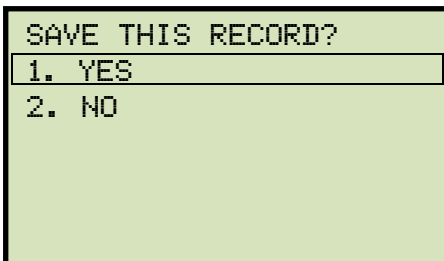

Press the **[1]** key (*YES*) to save the test record.

- h. The following screen will be displayed:

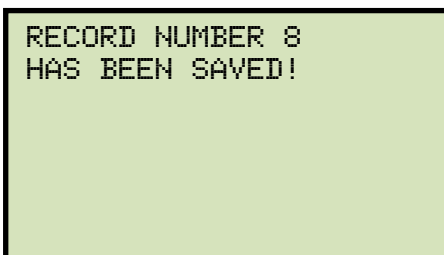

If a USB flash drive is connected to the unit, the following screen will be displayed instead:

**NOTES**

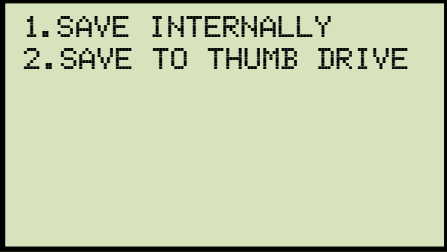

```
1. SAVE INTERNALLY
2. SAVE TO THUMB DRIVE
```

*1. SAVE INTERNALLY*

Press the **[1]** key (*SAVE INTERNALLY*) to save the test record to the unit's Flash EEPROM. The following screen will be displayed:

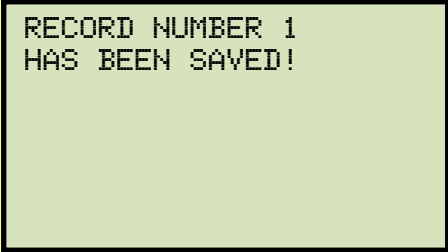

```
RECORD NUMBER 1
HAS BEEN SAVED!
```

*2. SAVE TO THUMB DRIVE*

Press the **[2]** key (*SAVE TO THUMB DRIVE*) to save the test record to the connected USB Flash drive. The following screen will be displayed:



```
REC_000 SAVED TO
THUMB DRIVE
```

Press any key to return to the "START-UP" menu.



### 3.5 Working With Test Records

#### 3.5.1. Viewing the Contents of the Working Memory

Whenever a test is performed and the reading is kept, the data is temporarily stored in the Auto-Ohm's working memory. You can view the test reading in the unit's working memory using the steps below:

- a. Start from the "START-UP" menu:

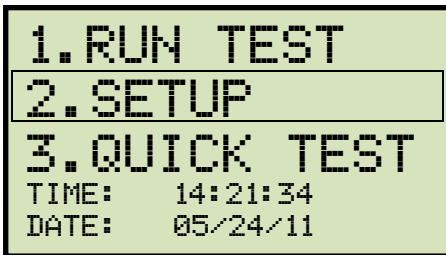

Press the **[2]** key (*SETUP*).

- b. The following screen will be displayed:

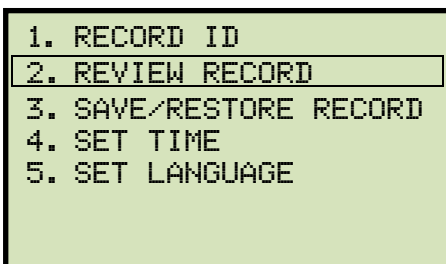

Press the **[2]** key (*REVIEW RECORD*).

- c. The following screen will be displayed:

#### Auto-Ohm 200 S3

The basic test record information will be displayed as shown:

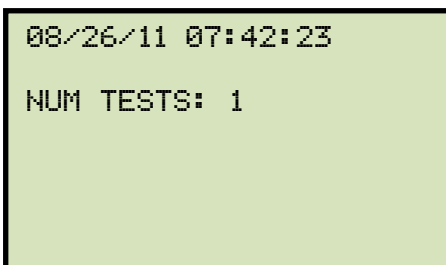

Press the **[v]** key. The test record details will be displayed as shown below:

#### DMOM-200 S3/DMOM-600

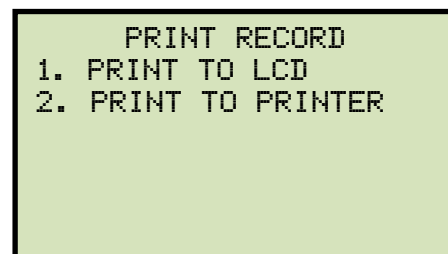

- 1. *PRINT TO LCD*

Press the **[1]** key (*PRINT TO LCD*) to display the test results on the unit's LCD screen. The basic test record information will be displayed as shown:

```
TEST NUMBER: 1
TEST CURRENT: 25A
RAMP: 5S    BURN: 5S

CUR: 25.01A
RES: 497μΩ
```

Press the **[STOP]** key to return to the "START-UP" menu.

```
08/26/11 07:42:23

NUM TESTS: 1
```

Press the **[√]** key. The test record details will be displayed as shown below:

```
TEST NUMBER: 1
TEST CURRENT: 25A
RAMP: 5S    BURN: 5S

CUR: 25.01A
RES: 497μΩ
```

Press the **[STOP]** key to return to the "START-UP" menu.

## 2. *PRINT TO PRINTER*

Press the **[2]** key (*PRINT TO PRINTER*) to print the test results on the unit's built-in thermal printer. The test results will be printed and you will be returned to the "START-UP" menu.

### 3.5.2. Saving Test Results to a Test Record

After performing a test, the user is presented the option to save the test results to the unit's Flash EEPROM or to a USB Flash Drive. If the test results are not saved immediately after performing a test, they will still remain in the working memory and can be saved later, as long as a new test has not been performed and the unit has not been turned off. Follow the steps below to save the test results from the working memory to a test record (the following procedure can also be used to re-save a restored test record to a new memory location or to a USB Flash Drive):

- a. Perform a test or restore a test record to the working memory (see section 3.5.3 and 3.5.4), and then start from the "START-UP" menu:

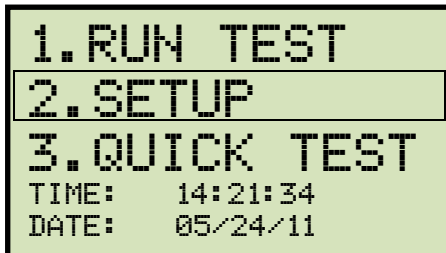

Press the **[2]** key (*SETUP*).

- b. The following screen will be displayed:

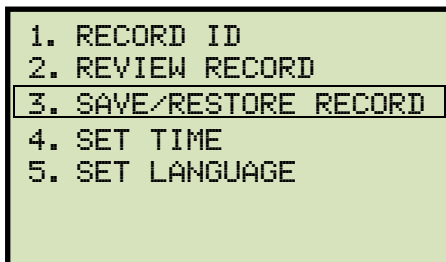

Press the **[3]** key (*SAVE/RESTORE RECORD*)

- c. The following screen will be displayed:

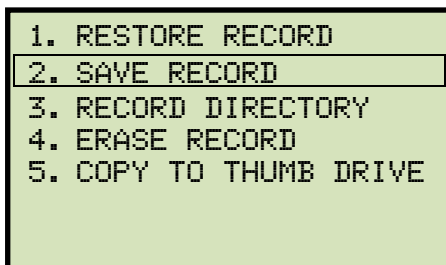

Option 5 (*COPY TO THUMB DRIVE*) will be listed only if a USB Flash drive is connected to the Auto-Ohm.

**NOTE**

Press the **[2]** key (*SAVE RECORD*).

If a USB Flash drive is connected to the unit, continue to step d.

If a USB Flash drive is NOT connected to the unit, continue to step e.

d. The following screen will be displayed:

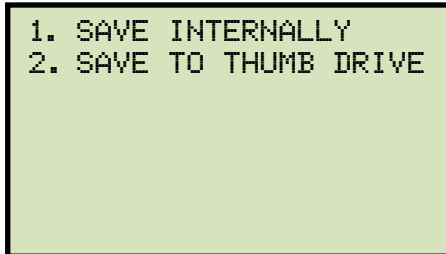

```
1. SAVE INTERNALLY
2. SAVE TO THUMB DRIVE
```

1. *SAVE INTERNALLY*

Press the **[1]** key (*SAVE INTERNALLY*) to save the test record to the unit's Flash EEPROM. **Continue to step e.**

2. *SAVE TO THUMB DRIVE*

Press the **[2]** key (*SAVE TO THUMB DRIVE*) to save the test record to the connected USB Flash drive. The following screen will be displayed:

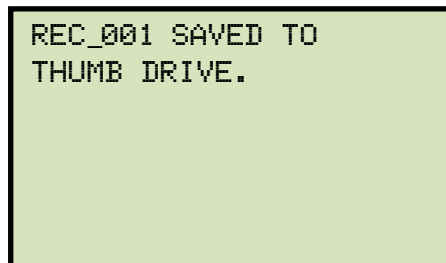

```
REC_001 SAVED TO
THUMB DRIVE.
```

Press any key to return to the "START-UP" menu.

e. The following screen will be displayed:

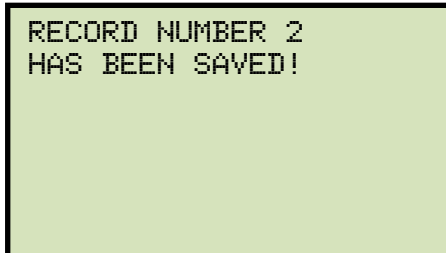

```
RECORD NUMBER 2
HAS BEEN SAVED!
```

Press any key to return to the "START-UP" menu.

### 3.5.3. Restoring a Test Record From Flash EEPROM

Use the steps below to restore a test record from the Auto-Ohm's internal Flash EEPROM to the working memory:

- a. Start from the "START-UP" menu:

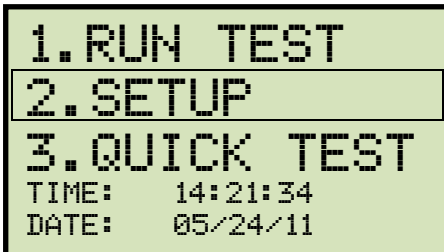

Press the **[2]** key (*SETUP*).

- b. The following screen will be displayed:

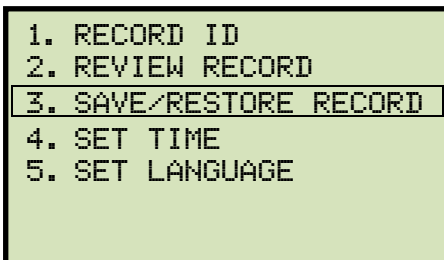

Press the **[3]** key (*SAVE/RESTORE RECORD*).

- c. The following screen will be displayed:

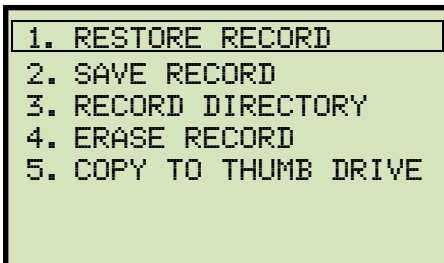

Option 5 (*COPY TO THUMB DRIVE*) will be listed only if a USB Flash drive is connected to the unit.

**NOTE**

Press the **[1]** key (*RESTORE RECORD*).

d. The following screen will be displayed:

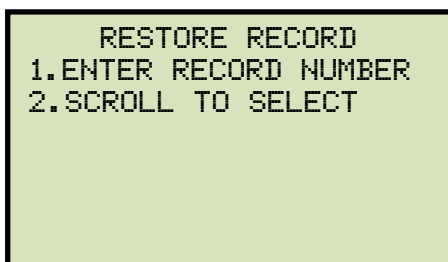

If you have a USB Flash drive inserted in the unit's "USB MEM" port, the following screen will be displayed instead of the above screen:

**NOTE**

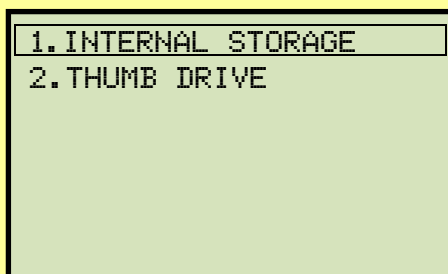

Press the **[1]** key (*INTERNAL STORAGE*).

The following screen will be displayed:

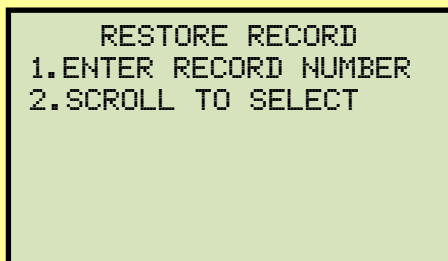

Continue with the steps below.

**1. ENTER RECORD NUMBER**

Press the **[1]** key (*ENTER RECORD NUMBER*) if you know the record number that you would like to restore.

1.1. The following screen will be displayed:



Type the record number using the alpha-numeric keypad and then press the **[ENTER]** key.

- 1.2. The following screen will be displayed:

```
RECORD RESTORED!  
REVIEW RECORD?  
1.YES  
2.NO
```

Press the **[1]** key (YES) to display the test record.

- 1.3. The basic information about the restored test record will be displayed as shown:

```
08/26/11 07:42:23  
  
NUM TESTS: 1
```

Press the **[v]** key. The test record details will be displayed as shown:

```
TEST NUMBER: 1  
TEST CURRENT: 25A  
RAMP: 5S    BURN: 5S  
  
CUR: 25.01A  
RES: 497μΩ
```

Press the **[STOP]** key to return to the "START-UP" menu. The restored test record will remain loaded in the working memory.

## 2. SCROLL TO SELECT

Press the **[2]** key (SCROLL TO SELECT) to scroll through a directory of the stored test records.

- 2.1. The following screen will be displayed:

```
RECORDS DIRECTORY  
  
"UP" TO SCROLL FWD  
"DWN" TO SCROLL RVS
```

Press the **[^]** button or the **[v]** key to display the next or previous test record, respectively.

The basic test record information will be displayed as shown:

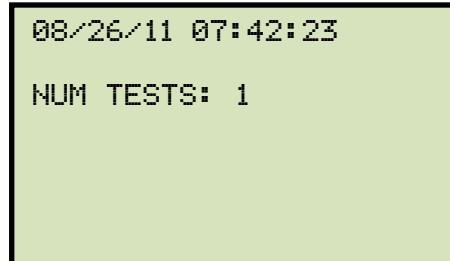

```
08/26/11 07:42:23
NUM TESTS: 1
```

When you have located the test record that you would like to restore, press the **[ENTER]** key. **Continue to step 1.2 on page 43.**



### 3.5.4. Restoring a Test Record From a USB Flash Drive

Use the steps below to restore a test record from a USB Flash drive to the Auto-Ohm's working memory:

- a. Make sure the USB Flash drive containing the test record(s) is inserted in the Auto-Ohm's USB Flash drive port ("USB MEM" port). Then start from the "START-UP" menu:

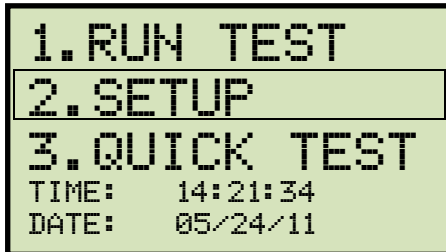

Press the **[2]** key (*SETUP*).

- b. The following screen will be displayed:

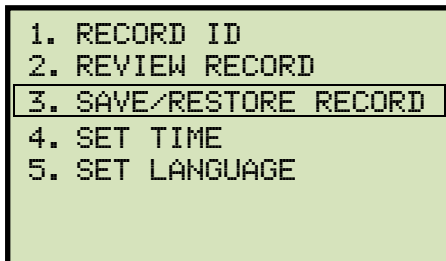

Press the **[3]** key (*SAVE/RESTORE RECORD*)

- c. The following screen will be displayed:

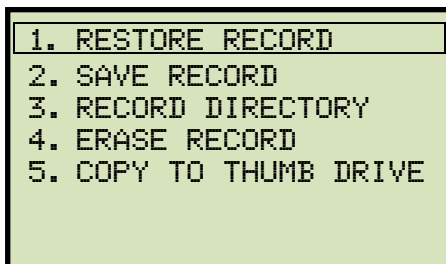

Press the **[1]** key (*RESTORE RECORD*).

- d. The following screen will be displayed:

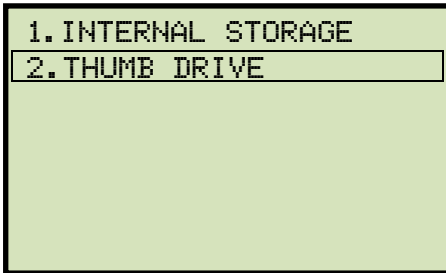

Press the **[2]** key (*THUMB DRIVE*).

- e. The following screen will be displayed:



Type the record number that you would like to restore using the alpha-numeric keypad and then press the **[ENTER]** key.

- f. The test record will be restored to the unit's working memory and the following screen will be displayed:

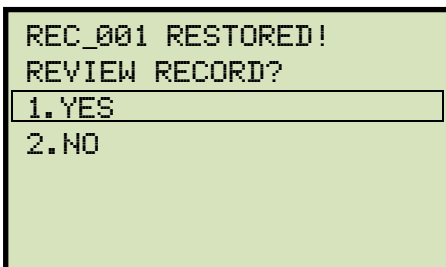

Press the **[1]** key (*YES*) to display the restored test record.

- g. The basic information about the restored test record will be displayed as shown below:

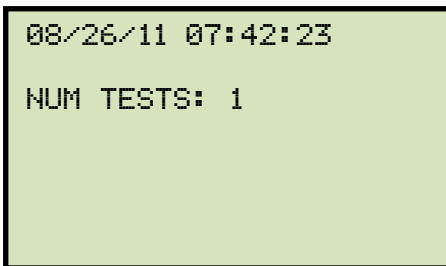

Press the **[√]** key. The test record details will be displayed as shown below:

```
TEST NUMBER: 1
TEST CURRENT: 25A
RAMP: 5S    BURN: 5S

CUR: 25.01A
RES: 497μΩ
```

Press the **[STOP]** key to return to the “START-UP” menu. The restored test record will remain loaded in the working memory.

### 3.5.5. Copying Test Records to a USB Flash Drive

Use the steps below to copy one or all test records from the unit's Flash EEPROM to a connected USB Flash drive:

- a. Make sure a USB Flash drive is connected to the unit's "USB MEM" port, and then start from the "START-UP" menu:

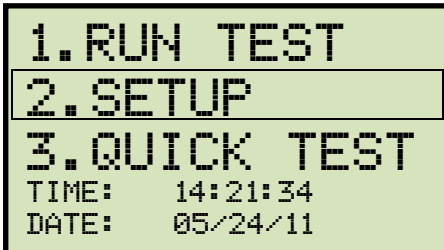

Press the **[2]** key (*SETUP*).

- b. The following screen will be displayed:

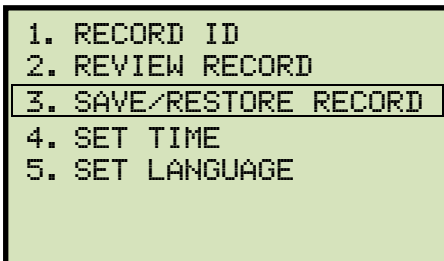

Press the **[3]** key (*SAVE/RESTORE RECORD*).

- c. The following screen will be displayed:

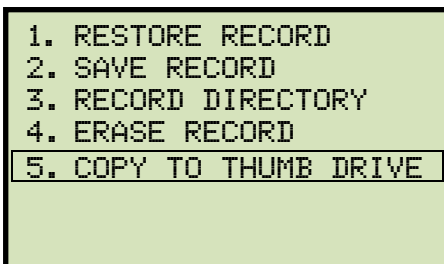

Press the **[5]** key (*COPY TO THUMB DRIVE*).

- d. The following screen will be displayed:

```
COPY REC TO THUMB DRV
1.COPY SINGLE RECORD
2.COPY ALL RECORDS
```

1. *COPY SINGLE RECORD*

Press the **[1]** key (*COPY SINGLE RECORD*) to copy a single test record from the unit's Flash EEPROM to the connected USB Flash drive. The following screen will be displayed:

```
ENTER RECORD NUMBER
TO COPY TO FLASH DRV

NUMBER:
```

Type the record number using the alpha-numeric keypad and then press the **[ENTER]** key. The test record will be copied to the USB Flash drive and the following screen will be displayed:

```
REC_013 SAVED TO
THUMB DRIVE
```

Press any key to return to the "START-UP" menu.

## 2. COPY ALL RECORDS

Press the **[2]** key (*COPY ALL RECORDS*) to copy all test records from the Auto-Ohm's Flash EEPROM to the connected USB Flash drive. All test records will be copied from the unit to the connected USB Flash drive. The following screen will be displayed when the process is finished:

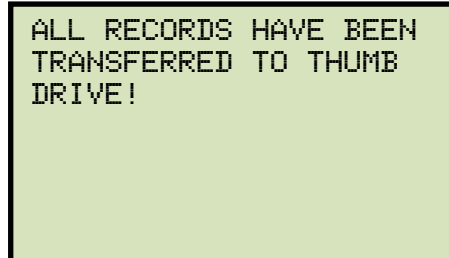

```
ALL RECORDS HAVE BEEN  
TRANSFERRED TO THUMB  
DRIVE!
```

Press any key to return to the "START-UP" menu.

### 3.5.6. Viewing the Test Record Directory

Use the steps below to browse through a directory of the test records stored in the Auto-Ohm's Flash EEPROM memory:

- a. Start from the "START-UP" menu:

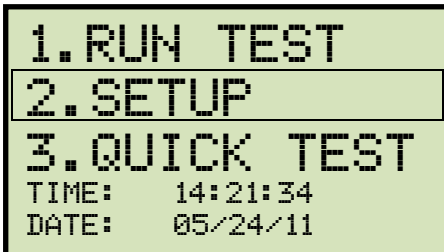

Press the **[2]** key (*SETUP*).

- b. The following screen will be displayed:

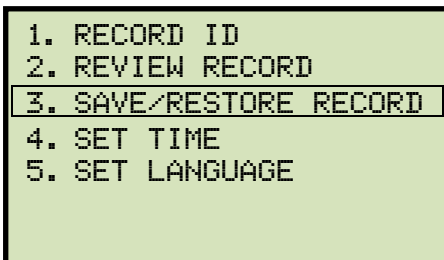

Press the **[3]** key (*SAVE/RESTORE RECORD*).

- c. The following screen will be displayed:

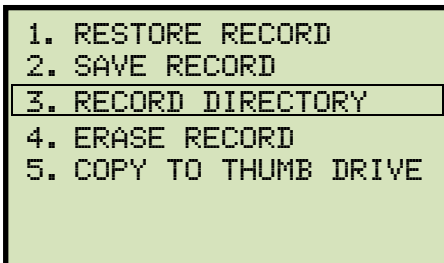

Option 5 (*COPY TO THUMB DRIVE*) is listed only if a USB Flash drive is connected to the unit.

**NOTE**

Press the **[3]** key (*RECORD DIRECTORY*).

- d. The following screen will be displayed:

```
RECORDS DIRECTORY
"UP" TO SCROLL FWD
"DWN" TO SCROLL RVS
```

Press the **[^]** or **[v]** key to scroll through the test record directory. The test record header will be displayed as shown:

```
#8      08/26/11 07:42
NUM TESTS: 1
```

You can continue to scroll through the record directory by pressing the **[^]** and **[v]** keys. Press the **[STOP]** key to return to the "START-UP" menu.



### 3.5.7. Erasing Test Records from the Flash EEPROM

Follow the steps below to erase test records from the Flash EEPROM

- a. Start from the "START-UP" menu:

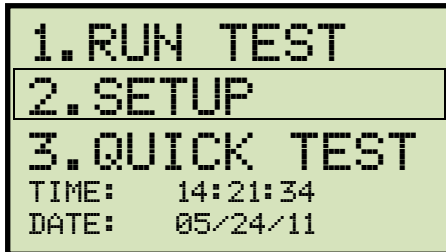

Press the **[2]** key (*SETUP*).

- b. The following screen will be displayed:

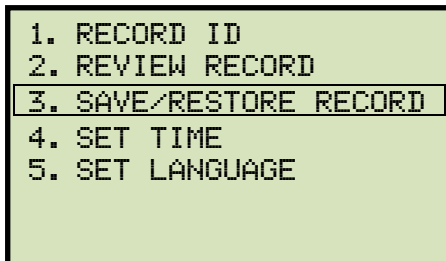

Press the **[3]** key (*SAVE/RESTORE RECORD*).

- c. The following screen will be displayed:

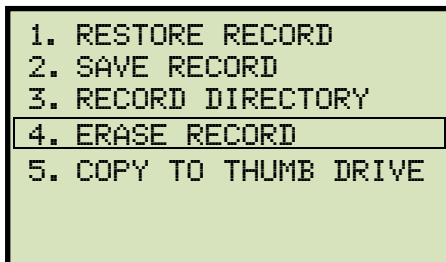

Press the **[4]** key (*ERASE RECORD*).

d. The following screen will be displayed:

```
ERASE RECORD
1.ERASE SINGLE REC.
2.ERASE ALL RECORDS
"STOP" TO EXIT
```



If you have a USB Flash drive inserted in the unit's "USB MEM" port, the following screen will be displayed instead of the above screen:

**NOTE**

```
1.ERASE INTERNAL REC
2.ERASE THUMB DRV REC
```

Press the **[1]** key (*ERASE INTERNAL REC*).

The following screen will be displayed:

```
ERASE RECORD
1.ERASE SINGLE REC.
2.ERASE ALL RECORDS
"STOP" TO EXIT
```

Continue with the steps below.

1. *ERASE SINGLE REC.*

Press the **[1]** key (*ERASE SINGLE REC.*) to erase a single test record from the unit's internal Flash EEPROM. The following screen will be displayed:

```
ERASE RECORD
1. ENTER RECORD NUMBER
2. SCROLL TO SELECT
```

1. *ENTER RECORD NUMBER*

Press the **[1]** key (*ENTER RECORD NUMBER*) if you know the record number that you would like to erase. The following screen will be displayed:

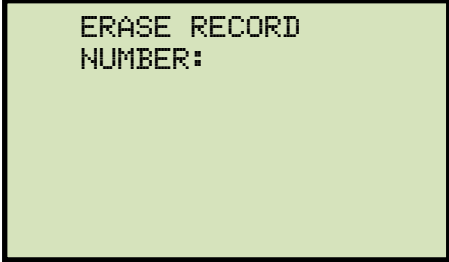

```
ERASE RECORD  
NUMBER:
```



You can cancel the process and return to the “START-UP” menu by pressing the **[STOP]** key.

**NOTE**

Type the record number that you would like to erase using the alpha-numeric keypad and then press the **[ENTER]** key. If you do not know the test record number, you can first view the test record directory using the instructions in section 3.5.6.

The following screen will be displayed while the record is being erased:

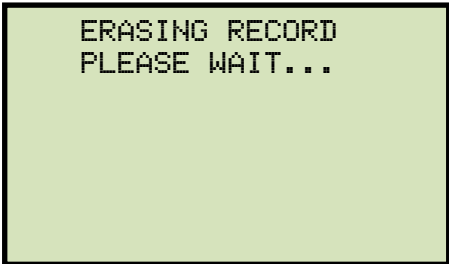

```
ERASING RECORD  
PLEASE WAIT...
```

The following screen will be displayed when the test record has been completely erased:

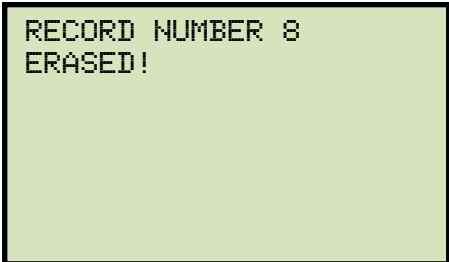

```
RECORD NUMBER 8  
ERASED!
```

Press any key to continue. You will be returned to the beginning of step d.

## 2. SCROLL TO SELECT

Press the **[2]** key (*SCROLL TO SELECT*) to scroll through the test record directory and locate the test record that you would like to erase. The following screen will be displayed:

```
RECORDS DIRECTORY
"UP" TO SCROLL FWD
"DWN" TO SCROLL RVS
```

Press the **[^]** or **[v]** key to scroll through the test record directory. The test record header will be displayed as shown:

```
#8      08/26/11 07:42
NUM TESTS: 1
```

You can continue to scroll through the record directory by pressing the **[^]** and **[v]** keys. Once you have located the test record you would like to erase, press the **[ENTER]** key. The selected test record will be erased and the following screen will be displayed:

```
RECORD NUMBER 9
ERASED!
```

Press any key to continue. You will be returned to the beginning of step d.

## 2. ERASE ALL RECORDS

Press the **[2]** key (*ERASE ALL RECORDS*) to erase all the test records from the unit's internal Flash EEPROM. The following warning screen will be displayed:

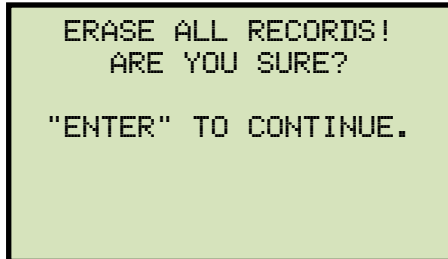

```
ERASE ALL RECORDS!  
ARE YOU SURE?  
  
"ENTER" TO CONTINUE.
```

You can press the **[STOP]** key to cancel the process and return to the "START-UP" menu.

Press the **[ENTER]** key to proceed with deleting all the test records from the unit's Flash EEPROM. The following screen will be displayed during the erasure process:

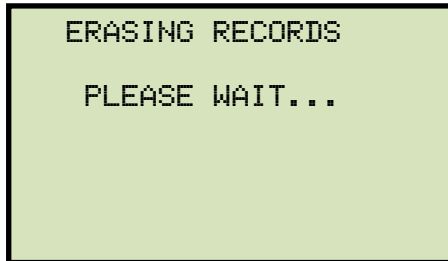

```
ERASING RECORDS  
  
PLEASE WAIT...
```

The following screen will be displayed when all test records have been completely erased:



```
RECORDS ERASED!
```

Press any key to return to the "START-UP" menu.

### 3.5.8. Erasing Test Records from a USB Flash Drive

Follow the steps below to erase test records from a USB Flash drive:

- a. Make sure a USB Flash drive is connected to the unit's "USB MEM" port, and then start from the "START-UP" menu:

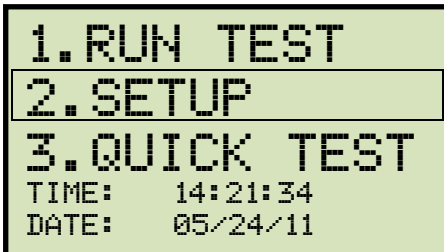

Press the **[2]** key (*SETUP*).

- b. The following screen will be displayed:

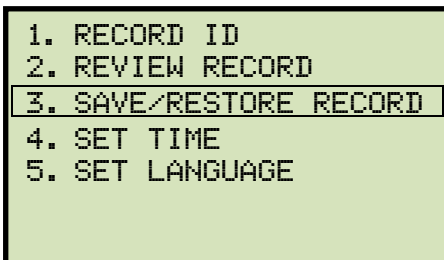

Press the **[3]** key (*SAVE/RESTORE RECORD*).

- c. The following screen will be displayed:

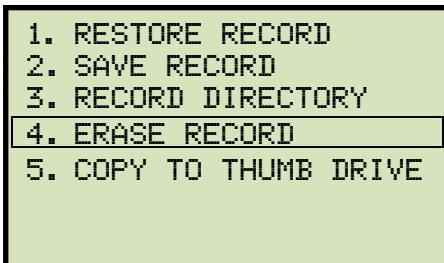

Press the **[4]** key (*ERASE RECORD*).

- d. The following screen will be displayed:

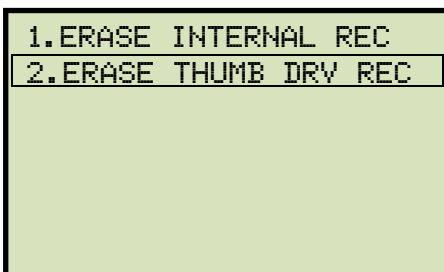

Press the **[2]** key (*ERASE THUMB DRV REC*).

- e. The following screen will be displayed:

```

ERASE RECORD
1.ERASE SINGLE REC.
2.ERASE ALL RECORDS

"STOP" TO EXIT

```

1. *ERASE SINGLE REC.*

Press the **[1]** key (*ERASE SINGLE REC.*) to erase a single test record from the connected USB Flash drive. The following screen will be displayed:

```

ERASE THUMB DRIVE
REC_

```

Type the record number that you would like to erase using the alpha-numeric keypad and then press the **[ENTER]** key. The test record will be erased from the USB Flash drive and the following screen will be displayed:

```

THUMB DRIVE RE001
ERASED!

```

Press any key to continue. You will be returned to the beginning of step e. Press the **[STOP]** key to return to the "START-UP" menu.

2. *ERASE ALL RECORDS*

Press the **[2]** key (*ERASE ALL RECORDS*) to delete all test records from the connected USB Flash drive. The following warning screen will be displayed:

```

ERASE ALL THUMB DRIVE
RECORDS!

ARE YOU SURE?

"ENTER" TO CONTINUE.

```

Press the **[STOP]** key if you do not want to erase all the test records. You will be returned to the "START-UP" menu.

Press the **[ENTER]** key to proceed with deleting all the test records from the connected USB Flash drive. The following screen will be displayed when all the records have been erased:

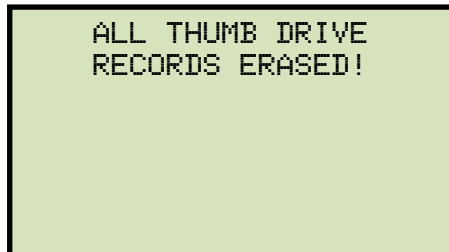

```
ALL THUMB DRIVE  
RECORDS ERASED!
```

Press any key to return to the "START-UP" menu.



## 4.0 Getting the Latest Firmware, Software, and Manuals

The latest firmware, software, and user's manuals can be downloaded from the Vanguard Instruments Company's web site at <http://www.vanguard-instruments.com>. In order to download these items from our site, you will first need to sign up for a FREE user account on our site. Also, your account must be approved before it can be used to download firmware, software, and user's manuals. Follow the steps below to sign up for an account and download the latest firmware, software and user's manuals:

- a. Visit our site at <http://www.vanguard-instruments.com>.
- b. On the left hand side of the page, click on the "Create new account" link:

- c. You will be presented with a sign-up form. Please complete all the required fields on the form and click on the "Create new account" button at the bottom of the page.
- d. Once your account has been created, it will be reviewed by our staff and usually approved within the hour during regular business hours.
- e. Once you have received the account approval email, visit our site again at <http://www.vanguard-instruments.com> and login to your account using your username and password.
- f. Click on the "Downloads" link at the top of the page:

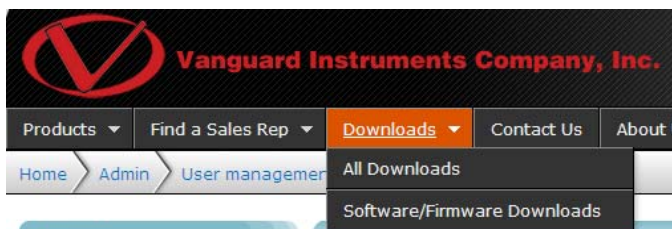

- g. The "Downloads" page will be displayed listing all Vanguard products along with the related firmware, software, and user's manuals. Click on any of these items to download them.



**Vanguard Instruments  
Company, Inc.**

**1520 S. Hellman Ave • Ontario, CA 91761 • USA**

**Phone: 909-923-9390 • Fax: 909-923-9391**

**[www.vanguard-instruments.com](http://www.vanguard-instruments.com)**

Copyright © 2015 by Vanguard Instruments Company, Inc.

Auto-Ohm 200/DMOM-200 S3/DMOM-600 User's Manual • Revision 2.3 • February 18, 2015 • TA